

Trademarks

Autel®, MaxiSys®, MaxiDAS®, MaxiScan®, MaxiCheck®, and MaxiRecorder® are trademarks of Autel Intelligent Technology Corp., Ltd., registered in China, the United States and other countries. All other marks are trademarks or registered trademarks of their respective holders.

Copyright Information

No part of this manual may be reproduced, stored in a retrieval system or transmitted, in any form or by any means, electronic, mechanical, photocopying, recording, or otherwise without the prior written permission of Autel.

Disclaimer of Warranties and Limitation of Liabilities

All information, specifications and illustrations in this manual are based on the latest information available at the time of printing.

Autel reserves the right to make changes at any time without notice. While information of this manual has been carefully checked for accuracy, no guarantee is given for the completeness and correctness of the contents, including but not limited to the product specifications, functions, and illustrations.

Autel will not be liable for any direct, special, incidental, indirect damages or any economic consequential damages (including the loss of profits).

IMPORTANT

Before operating or maintaining this unit, please read this manual carefully, paying extra attention to the safety warnings and precautions.

For Services and Support



pro.autel.com

www.autel.com



1-855-288-3587/1-855-AUTELUS (North America)

0086-755-86147779 (China)



Support@autel.com

For technical assistance in all other markets, please contact your local selling agent.

Safety Information

For your own safety and the safety of others, and to prevent damage to the device and vehicles upon which it is used, it is important that the safety instructions presented throughout this manual be read and understood by all persons operating or coming into contact with the device.

There are various procedures, techniques, tools, and parts for servicing vehicles, as well as in the skill of the person doing the work. Because of the vast number of test applications and variations in the products that can be tested with this equipment, we cannot possibly anticipate or provide advice or safety messages to cover every circumstance. It is the automotive technician's responsibility to be knowledgeable of the system being tested. It is crucial to use proper service methods and test procedures. It is essential to perform tests in an appropriate and acceptable manner that does not endanger your safety, the safety of others in the work area, the device being used, or the vehicle being tested.

Before using the device, always refer to and follow the safety messages and applicable test procedures provided by the manufacturer of the vehicle or equipment being tested. Use the device only as described in this manual. Read, understand, and follow all safety messages and instructions in this manual.

Safety Messages

Safety messages are provided to help prevent personal injury and equipment damage. All safety messages are introduced by a signal word indicating the hazard level.

DANGER

Indicates an imminently hazardous situation which, if not avoided, will result in death or serious injury to the operator or to bystanders.

WARNING

Indicates a potentially hazardous situation which, if not avoided, could result in death or serious injury to the operator or to bystanders.

Safety Instructions

The safety messages herein cover situations Autel is aware of. Autel cannot know, evaluate or advise you as to all of the possible hazards. You must be certain that any condition or service procedure encountered does not jeopardize your personal safety.

 **DANGER**

When an engine is operating, keep the service area WELL VENTILATED or attach a building exhaust removal system to the engine exhaust system. Engines produce carbon monoxide, an odorless, poisonous gas that causes slower reaction time and can lead to serious personal injury or loss of life.

 **SAFETY WARNINGS**

- Wear safety glasses and protective clothing.
- NEVER smoke or allow a spark or flame in vicinity of battery or engine.
- Have plenty of fresh water and soap nearby in case battery acid contacts skin, clothing or eyes.
- If battery acid contacts skin or clothing, wash immediately with soap and water. If acid enters eye, immediately flush eye with cold running water for at least ten minutes and get medical attention immediately.
- Use caution when working with metallic tools to prevent sparks or short circuits.
- Remove any jewelry or watches before you start servicing the battery.
- Keep hair, hands, and clothing as well as tester leads and cords away from moving blades and belts.

CONTENTS

	SAFETY INFORMATION	ii
	SAFETY MESSAGES	ii
	SAFETY INSTRUCTIONS	ii
1	USING THIS MANUAL	1
	CONVENTIONS	1
2	GENERAL INTRODUCTION	3
	2.1 MAXIBAS BT506 TESTER	4
	2.1.1 <i>Function Description</i>	4
	2.1.2 <i>Power Sources</i>	5
	2.1.3 <i>Technical Specifications</i>	6
3	GETTING STARTED	7
	3.1 POWER UP	7
	3.1.1 <i>Application Buttons</i>	9
	3.2 TEST PREPARATION	9
	3.2.1 <i>Inspect the Battery</i>	9
	3.2.2 <i>Connect to a Battery</i>	10
4	IN-VEHICLE TEST	11
	4.1 START THE TEST	12
	4.1.1 <i>Confirm Vehicle Information</i>	13
	4.2 BATTERY TEST	15
	4.3 STARTER TEST	19
	4.4 GENERATOR TEST	20
5	OUT-VEHICLE TEST	22
	5.1 TEST PROCEDURE	22
	5.2 TEST RESULTS	24
6	HISTORY	25
7	UPDATE	26
8	ME	27
	8.1 REPAIR REPORTS	28
	8.2 DATA LOGGING	29
	8.3 BAS MANAGER	29
	8.4 SETTINGS	30

8.5	USER MANUAL	30
8.6	BT508 UPGRADE	31
9	MAINTENANCE AND SERVICE	32
9.1	MAINTENANCE INSTRUCTIONS	32
9.2	TROUBLESHOOTING CHECKLIST	33
9.3	ABOUT BATTERY USAGE	34
9.4	SERVICE PROCEDURES	35
	<i>9.4.1 Technical Support</i>	35
	<i>9.4.2 Repair Service</i>	37
10	COMPLIANCE INFORMATION	38
11	WARRANTY	40

1

Using This Manual

This manual contains device usage instructions.

Some illustrations shown in this manual may contain modules and optional equipment that are not included in your system. Contact your sales representative for availability of other modules and optional tools or accessories.

Conventions

The following conventions are used.

Bold Text

Bold text is used to highlight selectable items such as buttons and menu options.

Example:

- Tap **OK**.

Notes and Important Messages

Notes

A **NOTE** provides helpful information such as additional explanations, tips, and comments.

Example:

NOTE

New batteries reach full capacity after approximately 3 to 5 charging and discharging cycles.

Important

IMPORTANT indicates a situation which, if not avoided, may result in damage to the test equipment or vehicle.

Example:

! **IMPORTANT**

Keep the cable away from heat, oil, sharp edges and moving parts. Replace damaged cables immediately.

Hyperlink

Hyperlinks, or links, that take you to other related articles, procedures, and illustrations are available in electronic documents. Blue italic text indicates an internal link and blue underlined text indicates a website link or an email address link.

Illustrations

Illustrations used in this manual are samples, the actual testing screen may vary for each vehicle being tested. Observe the menu titles and on-screen instructions to select the appropriate options.

2 General Introduction

MaxiBAS BT506

Battery & Electrical System Tester

The BT506 is a battery and electrical system analysis tool that uses Adaptive Conductance, an advanced battery analysis method to produce a more accurate examination of the battery's cold cranking ability and reserve capacity, vital to determining a battery's true health. The BT506 enables technicians to view the health status of the vehicle's battery and electrical system. Download the free and easy-to-use Battery Test mobile app that is available for iOS and Android devices. Together with the BT506, this app can complete battery & starting and charging system tests and display the test results.

2.1 MaxiBAS BT506 Tester

2.1.1 Function Description

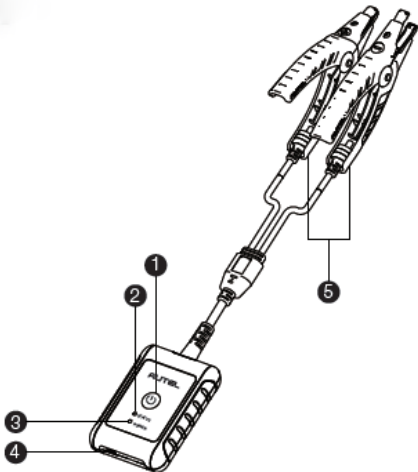

Figure 2-1 *MaxiBAS BT506*

- 1. Power Button
- 2. Status LED
- 3. Power LED
- 4. USB Port
- 5. Battery Clamp Cable

Table 2-1 LED Description

LED	Color	Description
Status LED	Flashing Green	The tester is communicating via USB cable.
	Flashing Blue	The tester is communicating via Bluetooth.
	Flashing Red	Battery clamps are connected to the wrong battery terminals.
Power LED	Green	<ul style="list-style-type: none"> ● Solid Green: The tester is powered on and the battery is sufficiently charged. ● Flashing Green: The tester is charging. (Becomes solid green when battery is fully charged.)
	Red	<ul style="list-style-type: none"> ● Flashing Red: The battery level is low. Please charge. ● Solid Red: The device is in boot mode.

2.1.2 Power Sources

The BT506 tester can receive power from the following sources:

- Internal Battery Pack
- AC/DC Power Supply

! IMPORTANT

Do not charge the battery when the temperature is below 0°C (32°F) or above 45°C (113°F).

1. Internal Battery Pack

The BT506 can be powered with the internal rechargeable battery.

2. AC/DC Power Supply — Using Power Adapter

The tester can be powered from an electrical outlet using the AC/DC power adapter. The AC/DC power supply also charges the internal battery pack.

2.1.3 Technical Specifications

Item	Description
Connectivity	<ul style="list-style-type: none">● USB 2.0, Type C● Bluetooth 4.2
Input Voltage	5 V DC
Working Current	< 150 mA at 12 V DC
Internal Battery	3.7 V / 800 mAh Lithium-ion Polymer battery
CCA Range	100 to 2000 A
Voltage Range	6 to 36 V
Working Temperature	- 10° C to 50° C (14° F to 122° F)
Storage Temperature	- 20° C to 60° C (- 4° F to 140° F)
Dimension (L x W x H)	107 mm (4.21") x 75 mm (2.95") x 26 mm (1.02") (clamp cable not included)
Weight	320 g (0.7 lb.)

3 Getting Started

Ensure that the unit is sufficiently charged before use.

NOTE

1. The images and illustrations depicted in this manual may differ slightly from the actual ones in your use scenario. The user interfaces for iOS & Android devices might be slightly different. This manual uses the user interface for Android devices as an example.
 2. The Battery Test app is compatible with 64-bit devices only.
 3. The BT506 tester can be used with a compatible Autel tablet. Your tablet's software may need to be updated for the app to display.
-

3.1 Power Up

1. Download and install app on your mobile device

Search for Battery Test in Google Play or the Apple App Store to download and install the app to your device. Alternatively, you can scan the QR code below to be directed to the Battery Test app download. On an Android device, you will be directed to Google Play, while iOS users will be directed to the Apple App Store.



2. Register and log in

- 1) Open the Battery Test app and tap **Register** on the **Log in** screen.
- 2) Follow the on-screen instructions to complete the registration.
- 3) Log in with your registered email address and password.

3. Pair the BT506

Pair the BT506 with the Battery Test app by scanning the QR code on the back of the tester or via Bluetooth pairing.







4. Install the diagnostic data package

Tap the **Update** button on the **Home** screen and install the vehicle diagnostic application.

NOTE

1. If you already have an existing Autel account, log in with your registered Autel account email and password.
 2. If you try to use functions from the main menu without installing the vehicle software from the **Update** screen, a message will appear on the **Home** screen reminding you to install the vehicle software first.
 3. The recommended pairing process is by scanning the QR code on the back of the BT506.
-

3.1.1 Application Buttons

Button	Name	Description
	In-vehicle test	Tests batteries that are installed in a vehicle. (See page 11.)
	Out-vehicle test	Tests batteries that are not installed in a vehicle. (See page 22.)
	History	Accesses battery test results. (See page 25.)
	Battery change	Operation guide for battery change.
	Battery reset	Accesses the Battery reset function.
	Diagnostics	Accesses the unit's diagnostics functions.

NOTE

Purchase the MaxiVCI V200P to perform Battery change, Battery reset, and the Diagnostics functions. Please see the Upgrade section on page 31 for more information.

3.2 Test Preparation

3.2.1 Inspect the Battery

Before starting a test, inspect the battery for:

- Cracking, buckling or leaking. If you see any of these defects, replace the battery.

- Corroded, loose or damaged cables and connections. Repair or replace as needed.
- Corrosion on the battery terminals, and dirt or acid on the case top. Clean the case and terminals using a wire brush and a mixture of water and baking soda.

3.2.2 Connecting to a Battery

Press and hold the **Lock/Power** button to turn on the BT506.

Connect the red clamp to the positive (+) terminal and the black clamp to the negative (-) terminal of the battery.

The black clamp is installed with an infrared sensor near the clamp mouth that tests the battery temperature. The battery temperature will appear on the Battery Test Result screen or in the Battery Test Report.

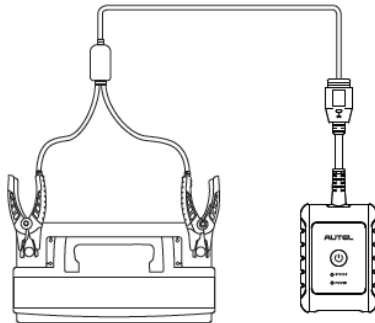

4 In-vehicle Test

The in-vehicle test is used for testing batteries that are installed in a vehicle. An in-vehicle test includes the Battery test, Starter test, and Generator test, and determines the health status of the battery, the starter, and the generator, respectively.

! IMPORTANT

1. Before using the diagnostic functions, download the desired vehicle software on the **Update** screen.
2. A Disclaimer page will appear when accessing any function on the **Home** screen for the first time. Please read the end user agreement and TAP **Accept** to continue. If you tap **Decline**, you will not be able to use the features properly.

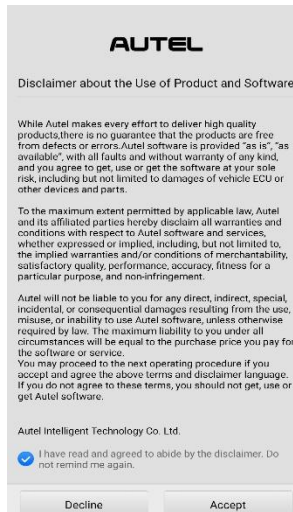

Figure 4-1 Sample Disclaimer Screen

4.1 Start the Test

Select **In-vehicle test** on the **Home** screen.

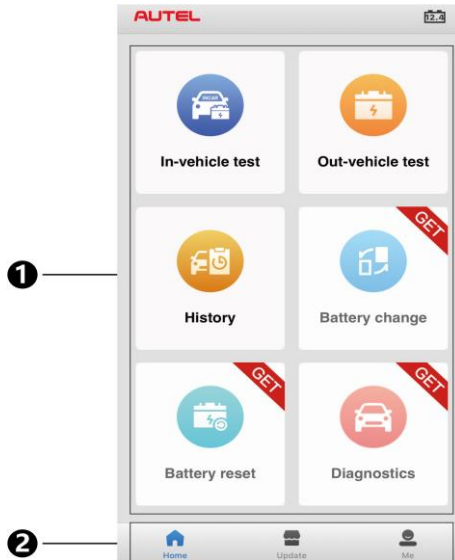

Figure 4-2 *Sample Home Screen*

- 1) **Home** screen — Displays three major functions of the BT506, including In-vehicle test, Out-vehicle test, and History. Three other optional functions also display on the screen.
- 2) **Navigation Button** — Displays **Home** screen, **Update** and **Me**. The **Update** allows users to install the vehicle diagnostic application. The **Me** panel provides information related to the user account, including the Repair Report, Data Logging, BAS Manager, Settings, User Manual, and 508 Upgrade.

4.1.1 Confirm Vehicle Information

The screenshot shows a mobile application interface titled "Vehicle Information". It features several input fields with dropdown menus and a table of battery specifications.

Fields and values:

- License: [Empty]
- VIN: 1C4BJWFG5GL131334
- Make: Jeep
- Year: 2016
- Model: JK-WRANGLER
- Others: None

Type	Standard	Capacity
		590
		595
FLOODED	CCA	600
AGM	SAE	605
AGM SPIRAL	CA	610

At the bottom of the screen, there are two buttons: "Battery location" and "Next".

Figure 4-3 Sample Vehicle Information Screen

1. The vehicle information will be automatically populated when vehicle communication is established. A Battery Information tab will pop up from the bottom of the screen.





Figure 4-4 Sample Battery Information Screen

2. Tap the icon on the tab to return to the Vehicle information screen. Tap **Battery Location** on the bottom left corner of the screen and view the battery location diagram.
3. Find the battery, check the battery information on it and select the correct battery parameters on the screen.
4. Confirm all the items on the Vehicle information screen. Tap the corresponding field to manually input the correct parameters, if needed. Tap **Next** to continue.

4.2 Battery Test

Table 4-1 *Upper Toolbar Buttons*

Name	Button	Description
Back		Returns to the previous screen.
ESC		Returns to the Diagnosis (or Diagnostics) screen.
Battery Connection		Displays the battery connection status. The number on the icon indicates the real-time voltage of the tested battery.

NOTE

On an Android device, a tap on the Battery Connection button will display the BAS Manager screen. On an iOS device, if the tester is not paired, a message will appear to prompt the user to pair the battery tester. No other action or screen will be displayed on the iOS device if already paired with the battery tester.

5. The Clamp Connection Diagram will appear. Follow the instructions to connect the clamp cables and tap **Next** to continue.

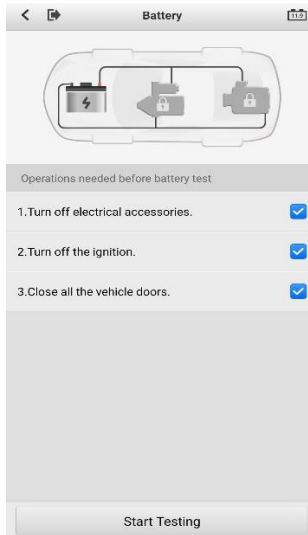

Figure 4-5 *Sample Battery Information Screen*

6. Follow the on-screen instructions, check the boxes and tap **Start Testing**.
7. Wait until the test is completed. The test results will appear as shown below:



Figure 4-6 Sample Battery Test Result Screen

- 1) Process Buttons
- 2) Test Report
- 3) Function Buttons

Process Buttons

Tap any of the process buttons to advance to the corresponding test — battery test, starter test or generator test. A status icon will appear on the bottom right corner of the button, indicating the test results.

Battery Test Results

The battery test results include a color-coded results summary, a list of test data, and repair tips.

Table 4-2 *Battery Test Results*

Result	Repair Tip
Good Battery	Battery is in good condition.
Good & Recharge	Battery is normal at present. The battery should be charged.
Charge & Retest	Charge the battery and retest it.
Bad Cell	Replace the battery.
Replace Battery	Replace the battery.

Function Buttons

The Function Buttons displayed at the bottom of the screen will vary depending on the operation. The table below provides a brief description of these operations:

Name	Description
Report	Tap to view the test data and results in report form. Tap Save to save test reports as a PDF document.
Continue	Tap to perform the next test.

NOTE

Please always complete the Battery test before you proceed to the Starter and Generator tests.

4.3 Starter Test

8. Follow the on-screen instructions to complete the test. Start the engine and let it idle. The test results will be displayed as follows:

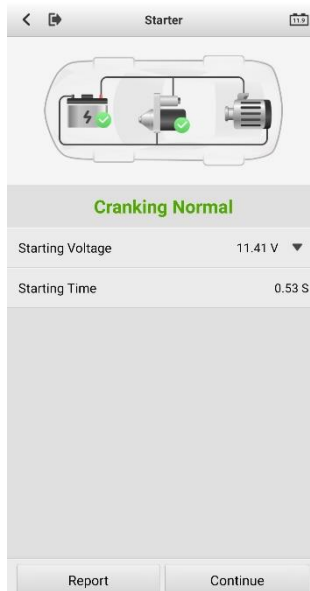

Figure 4-7 Sample Starter Test Results Screen

Table 4-3 Starter Test Results

Result	Description
Cranking Normal	Starter is good.
Current Too Low	Low momentary discharge capacity.
Voltage Too Low	Low battery storage capacity.
Not Started	Starter is not detected for starting.

4.4 Generator Test

- 9. Follow the on-screen instructions to complete the test. The test results will be displayed as follows:

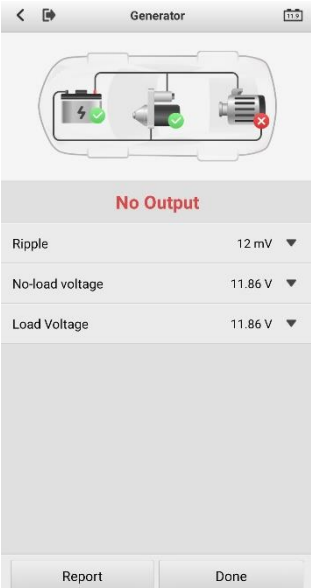

Figure 4-8 Sample Generator Test Results Screen

Table 4-4 *Generator Test Results*

Result	Description
Charging Normal	The generator is good.
Output Too Low	<ul style="list-style-type: none"> ● The belt linking the starter and the generator is loose; ● The cable linking the starter and battery is loose or corroded.
Output Too High	<ul style="list-style-type: none"> ● The generator is not properly connected to the ground; ● The voltage adjuster is broken and needs replacement.
Ripple Too Large	The commutation diode is broken and needs repair or replacing.
No Output	<ul style="list-style-type: none"> ● The cable is loose. ● Some vehicles with power management systems do not provide a path for charging due to the sufficient load capacity of the battery; ● The generator or the voltage adjuster is broken and needs replacing.

5 Out-vehicle Test

Out-vehicle test is used to test the condition of batteries that are not connected to a vehicle. This function aims to check the health status of the battery only. The battery types and standards able to be tested are as follows:

Types: FLOODED, AGM, AGM SPIRAL, EFB, and GEL

Standards: CCA, SAE, CA, EN, IEC, DIN, JIS and MCA

5.1 Test Procedure

1. Connect the clamps to the battery terminals.
2. Select the appropriate battery type, rating standard, and capacity. Tap **Start Testing** to start the test.

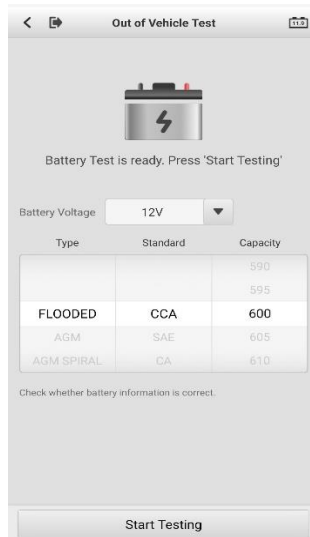

Figure 5-1 Sample Out-vehicle Test Screen

3. The test result will be displayed in a few seconds.

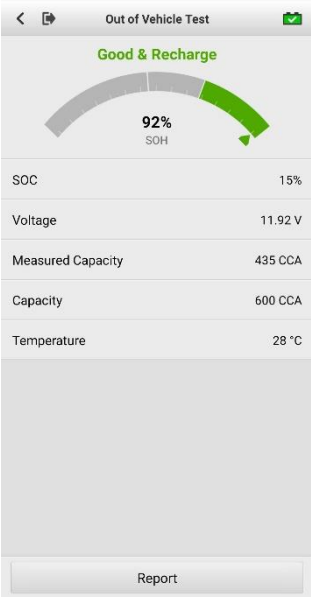

Figure 5-2 Sample Out-vehicle Test Screen

5.2 Test Results

Icons are color-coded to indicate status.

Result	Description
Good Battery	Battery meets required standards.
Good & Recharge	Battery is good, but low on charge. Fully charge the battery. Check for causes of low charge.
Charge & Retest	Retest after charging.
Replace Battery	Battery fails to meet industry-accepted standards.
Bad Cell	Battery fails to meet industry-accepted standards.

6 History

This function stores results of vehicle and battery testing. The information is displayed in list form, offering a summary review of just-tested and previously-tested vehicles and/or batteries.

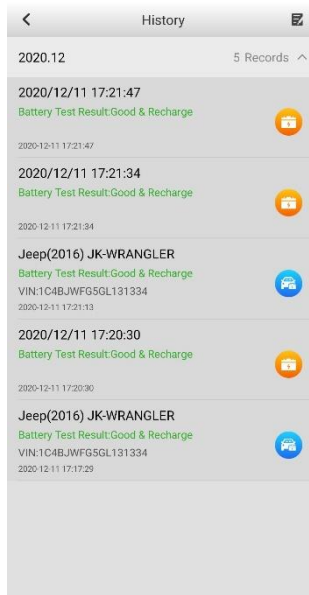



Figure 6-1 Sample Diagnostics Test Records Screen

Tap the  button on the top right corner of the screen to delete the selected report.

7 Update

The **Update** function enables users to download and install the vehicle diagnostic application and software updates as they become available. Please log in with your Autel ID and pair the MaxiBAS BT506 device with your account. The vehicle software (Battery test) is free and permanently valid, you can download it through **Update**.

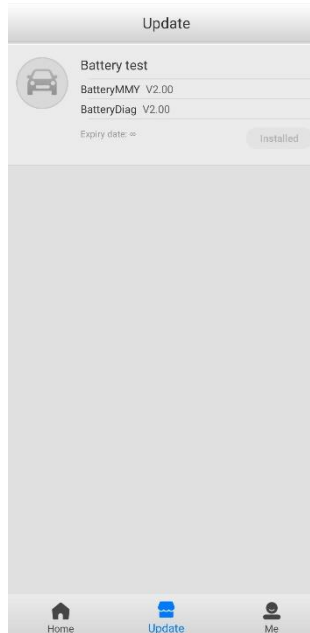

Figure 7-1 Sample Update Screen

8 Me

In this section, users have access to functions including Repair Reports, Data Logging, BAS Manager, Settings, User Manual, and to the BT508 Upgrade.

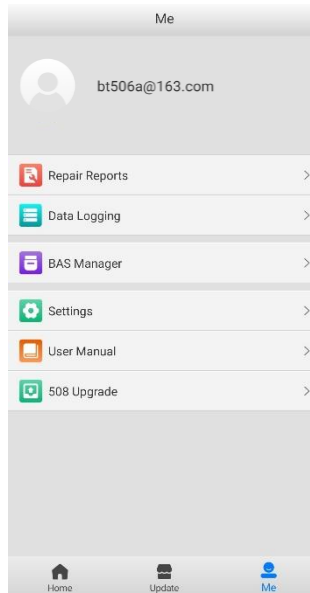

Figure 8-1 *Sample Me Screen*

Registration is required for these functions to be available.

➤ **To complete registration:**

1. Tap the **Register** button on the **Log in** screen.
2. Enter your email address. Tap the **Verification code** button and an email will be sent to your address with your unique verification code. Enter the verification code and your account password on the registration screen.
3. Tap **Register** to complete the registration.

8.1 Repair Reports

The Battery Test app can save a history of repair reports from your diagnostic sessions. A PDF can also be generated for the easy viewing, sharing, and printing of these reports.

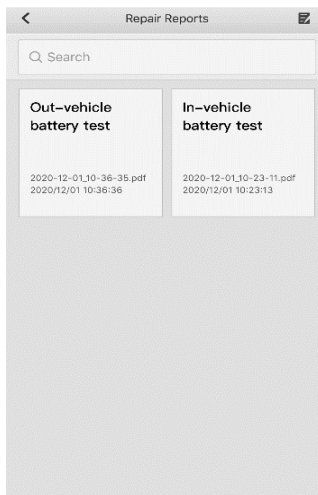

Figure 8-2 *Sample Repair Reports Screen*

8.2 Data Logging

The Data Logging option allows you to launch the Autel Support platform directly to view all records on the diagnostic system. The Data Logging option keeps all test records, whether submitted (**Feedback**) or not submitted (**Not Feedback**), in addition to a history of your most recent 20 test records (**History**). Autel support personnel will receive and process any submitted reports through the Support platform.

8.3 BAS Manager

The BAS Manager displays Bluetooth connection status, and enables users to check current firmware version and update it when available.



Figure 8-3 Sample BAS Manager Screen

1. **Bluetooth connection**

Users can pair the mobile device with the BT506 tester via Bluetooth. The serial number of the tester will display on the screen. Tap **Stop** on the top right corner of the screen to stop scanning. If the Bluetooth connection is successful, the status will display as **Paired**.

2. **Firmware upgrade**

Tap **Firmware upgrade** to check for available updates. Tap the upgrade notification message to download and install.

NOTE

When initiating a diagnostic function, the screen will display a notification message to prompt the user to update the firmware if a newer version is available.

8.4 Settings

Select the **Settings** application to display the settings menu.

Unit

English or **Metric** measurements can be used. By default, **Metric** is chosen. Tap **English** to have the tool display measures in **English** units.

Tips Reset

Reset the tips feature to turn on the on-screen guidance when using the tool.

8.5 User Manual

This option launches the User Manual for the MaxiBAS BT506.

8.6 BT508 Upgrade

Purchase the Autel VCI V200P to upgrade the BT506 to the BT508 in order to be able to perform battery reset, battery change, and full system fault scan for one vehicle brand. After purchasing the VCI, follow the on-screen instructions to download BT508 functions.



Figure 8-4 Sample BT508 Upgrade Screen

9 Maintenance and Service

To ensure that your MaxiBAS tester performs at its optimum level, we advise that the product maintenance instructions discussed in this section are read and followed.

9.1 Maintenance Instructions

Maintain the device with the following precautions and guidance in mind.

- Do not use any abrasive cleansers, detergents, or automotive chemicals on the tester.
- Maintain all devices in dry conditions and keep them within normal operating temperatures.
- Do not store the devices in humid, dusty or dirty areas.
- Check the housing, wiring, and connectors for dirt and damage before and after each use.
- At the end of each work day, wipe the device housing, wiring, and connectors clean with a damp cloth.
- Do not attempt to disassemble the tester.
- Do not drop or cause severe impact to the device.
- Use only authorized battery chargers and accessories. Any malfunction or damage caused by the use of unauthorized battery chargers and accessories will void the product warranty.
- Ensure that the battery charger does not come in contact with conductive objects.

9.2 Troubleshooting Checklist

A. When the tester does not work properly:

- Ensure the tester has been registered.
- Ensure tool's software is updated.
- Check all cables, connections, and indicators to ensure proper communication between tool and vehicle and battery.

B. When you are unable to charge the tester:

- Check the connections.
- Ensure you are using the power supply included with the tool.
- Ensure the tool is being charged in a room of moderate temperature, not too hot or too cold.
- Contact technical support or your authorized Autel supplier if the unit or charger is damaged.

C. When Bluetooth connection fails:

- The Bluetooth signal is out of range. Move the battery tester closer to your mobile device.
- On your mobile device, turn Bluetooth off and then on.
- Power your mobile device off and then on.

 **NOTE**

Contact Autel technical support or your authorized Autel supplier if the problem persists.

9.3 About Battery Usage

Your tester is powered by a built-in Lithium-ion Polymer battery. This means that, unlike other battery technologies, the battery can be recharged with some remaining battery life without damaging its longevity.

 **DANGER**

1. The built-in Lithium-ion Polymer battery is factory replaceable only; incorrect replacement or tampering with the battery pack may cause an explosion.
 2. Do not use a damaged battery charger.
-
- Do not disassemble or open, crush, bend or deform, puncture or shred.
 - Do not modify or remanufacture, attempt to insert foreign objects into the battery, expose to fire, explosion or other hazards.
 - Make sure to only use the charger and USB cables that are supplied with the tool. The use of other chargers and/or USB cables might result in malfunction or damage to the tool.
 - Only use the charging device that has been qualified with device per the standard. Use of an unqualified battery or charger may present a risk of fire, explosion, leakage, or other hazards.
 - Avoid dropping the tester. If the tester is dropped, especially on a hard surface, and the user suspects damage, contact Autel technical support.
 - The battery recharging time varies depending on the remaining battery capacity.
 - Battery life inevitably shortens over time.
 - Overcharging may shorten battery life. Remove the tester from its charger once it is fully charged. Unplug the charger once charging is complete.

- Ensure the tool is stored in a dry and moderate temperature area. Extreme heat or cold may result in damage to the tool and/or its battery.

9.4 Service Procedures

This section introduces information for technical support, repair service, and application for replacement or optional parts.

9.4.1 Technical Support

If you have any question or problem on the operation of the product, please contact us.

AUTEL NORTH AMERICA

- **Phone:** 1-855-AUTEL-US (288-3587) (855-288-3587) Monday-Friday 9am-6pm EST
- **Website:** www.autel.com
- **Email:** ussupport@autel.com
- **Address:** 175 Central Avenue, Suite 200, Farmingdale, New York, USA 11735

AUTEL EUROPE

- **Phone:** 0049 (0) 6103-2000520 (Monday-Friday, 9:00AM-6:00PM Berlin Time)
- **Website:** www.autel.eu
- **Email:** sales.eu@autel.com, support.eu@autel.com

- **Address:** Adalperostraße 82, 85737 Ismaning, Germany

AUTEL CHINA HQ

- **Phone:** 0086-755-2267-2493 (Monday-Friday, 9:00AM-6:00PM Beijing Time)
- **Website:** www.autel.com
- **Email:** support@autel.com
- **Address:** 7th, 8th and 10th floor, Building B1, Zhiyuan, Xueyuan Road, Xili, Nanshan, Shenzhen, 518055, China.

AUTEL LATIN AMERICA

- **Website:** www.autel.com
- **Email:** sales.latin@autel.com, latsupport02@autel.com
- **Address:** Avenida Americas 1905, 6B, Colonia Aldrete, Guadalajara, Jalisco, Mexico

AUTEL APAC

- **Phone:** +045 5948465
- **Website:** www.autel.com/jp/
- **Email:** sales.jp@autel.com, support.jp@autel.com
- **Address:** 719, Nissou Building, 3-7-18, Shinyokohama, Kouhoku, Yokohama, Kanagawa, Japan 222-0033

Autel IMEA DMCC

- **Phone:** +971 585 002709
- **Website:** www.autel.com
- **Email:** sales.imea@autel.com, imea-support@autel.com
- **Address:** Office 1006-1010, Cluster C, Fortune Tower, Jumeirah Lakes Tower (JLT), Dubai, U.A.E

For technical assistance in other markets, please contact your local distributor.

9.4.2 Repair Service

If it becomes necessary to return your device for repair, please download the repair service form from www.autel.com, and fill in the form. The following information must be included:

- Contact name
- Return address
- Telephone number
- Product name
- Complete description of the problem
- Proof-of-purchase for warranty repairs
- Preferred method of payment for non-warranty repairs



NOTE

For non-warranty repairs, payment can be made with Visa, Master Card, or with approved credit terms.

Send the device to your local distributor, or to the below address:

7th, 8th and 10th Floor, Building B1, Zhiyuan, Xueyuan Road, Xili, Nanshan, Shenzhen, 518055, China

10 Compliance Information

FCC Compliance

FCC ID: WQ8BATS-BT508

This device complies with part 15 of the FCC Rules. Operation is subject to the following two conditions:

- a) This device may not cause harmful interference, and
- b) This device must accept any interference received, including interference that may cause undesired operation.

 **WARNING**

Changes or modifications not expressly approved by the party responsible for compliance could void the user's authority to operate the equipment.

 **NOTE**

This equipment has been tested and found to comply with the limits for a Class B digital device, pursuant to Part 15 of the FCC Rules. These limits are designed to provide reasonable protection against harmful interference in a residential installation.

This equipment generates uses and can radiate radio frequency energy and, if not installed and used in accordance with the instructions, may cause harmful interference to radio communications. However, there is no guarantee that interference will not occur in a particular installation. If this equipment does cause harmful interference to radio or television reception, which can be determined by turning the equipment off and on, the user is encouraged to try to correct the interference by one or more of the following measures:

-- Reorient or relocate the receiving antenna.

- Increase the separation between the equipment and receiver.
- Connect the equipment into an outlet on a circuit different from that to which the receiver is connected.
- Consult the dealer or an experienced radio/TV technician for help.

FCC Radiation Exposure Statement

This equipment complies with FCC radiation exposure limits set forth for an uncontrolled environment. This equipment should be installed and operated with minimum distance 20cm between the radiator & your body.

RF Warning Statement

The device has been evaluated to meet general RF exposure requirement. The device can be used in portable exposure condition without restriction.
RF ETSIEN300328 V2.2.2 (2019-07)

RoHS COMPLIANCE

This device is declared to be in compliance with the European RoHS Directive 2011/65/EU and Directive (EU) 2015/863. IEC62321

CE COMPLIANCE

This product is declared to conform to the essential requirements of the following Directives and carries the CE mark accordingly:

EMC ETSIEN301489-1 V2.2.3 (2019-11) ETSIEN301489-17 V3.1.1 (2017-02)

Safety EN62368-1: 2014+A11: 2017

Health EN50663: 2017: EN62479: 2010

Directive 2014/53/EU



11 Warranty

Limited One Year Warranty

Autel Intelligent Technology Corp., Ltd. (the Company) warrants to the original retail purchaser of this MaxiBAS battery tester, that should this product or any part thereof during normal consumer usage and conditions, be proven defective in material or workmanship that results in product failure within one (1) year period from the date of purchase, such defect(s) will be repaired, or replaced (with new or rebuilt parts) with Proof of Purchase, at the Company's option, without charge for parts or labor directly related to the defect(s).

The Company shall not be liable for any incidental or consequential damages arising from the use, misuse, or mounting of the device. Some states do not allow limitation on how long an implied warranty lasts, so the above limitations may not apply to you.

This warranty does not apply to:

- a) Products subjected to abnormal use or conditions, accident, mishandling, neglect, unauthorized alteration, misuse, improper installation or repair or improper storage;
- b) Products whose mechanical serial number or electronic serial number has been removed, altered or defaced;
- c) Damage from exposure to excessive temperatures or extreme environmental conditions;
- d) Damage resulting from connection to, or use of any accessory or other product not approved or authorized by the Company;
- e) Defects in appearance, cosmetic, decorative or structural items such as framing and non-operative parts.
- f) Products damaged from external causes such as fire, dirt, sand, battery leakage, blown fuse, theft or improper usage of any electrical source.

! **IMPORTANT**

All contents of the product may be deleted during the process of repair. You should create a back-up copy of any contents of your product before delivering the product for warranty service.
