

# Dolphin Generation 2 Maintenance Manual **V1.0**

Note: This manual is applicable to models with serial number  
KM10、KM11 of Dolphin Generation II model.

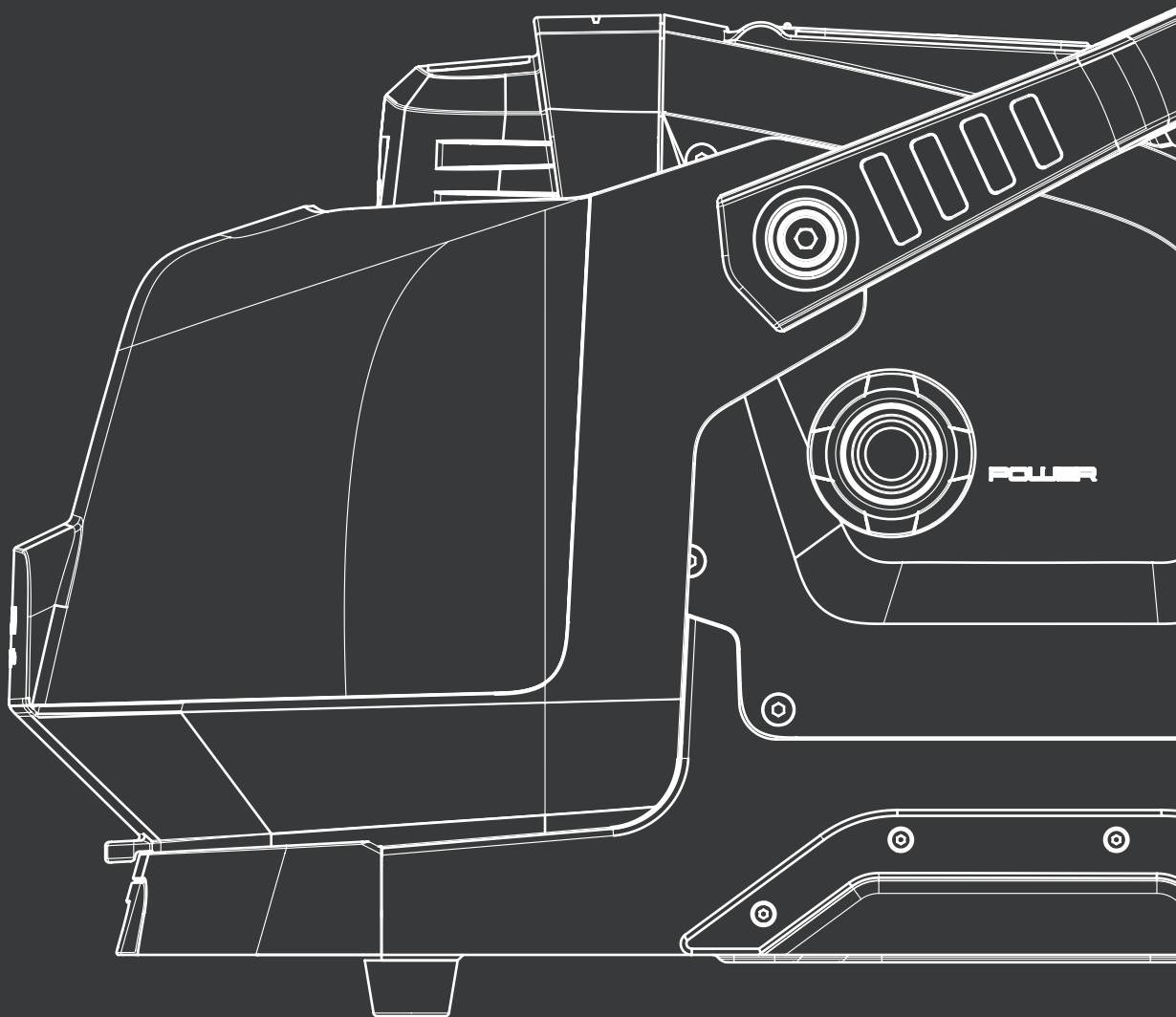

# 1 Machine disassembly exploded pictures

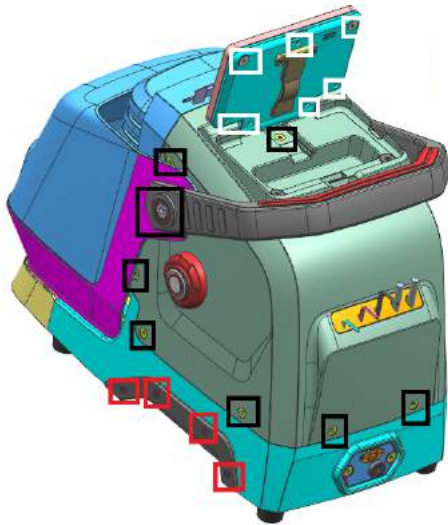

P1

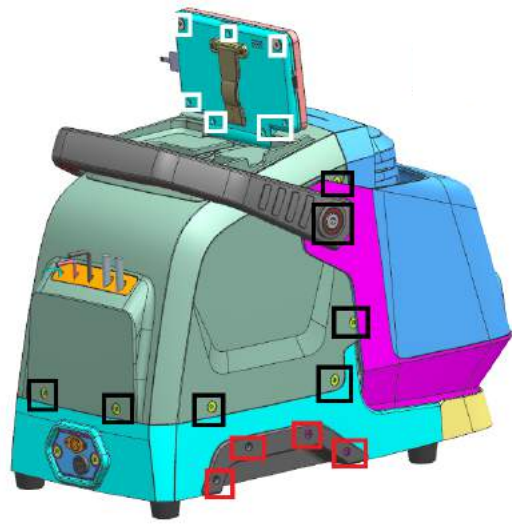

P2

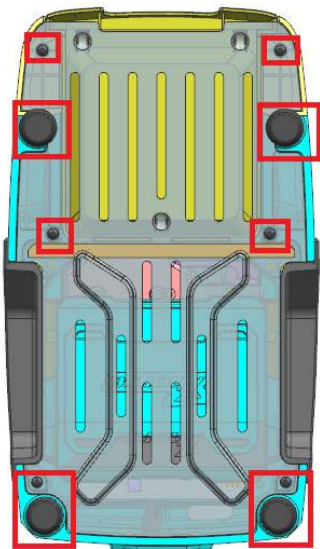

P3

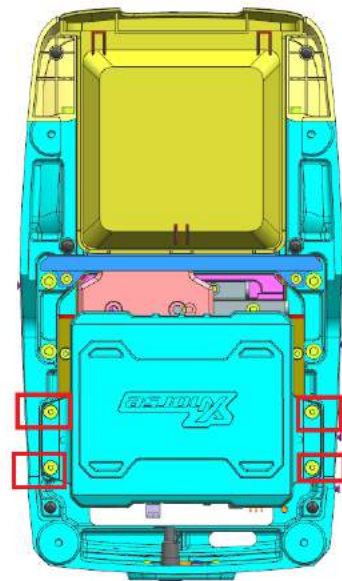

P4

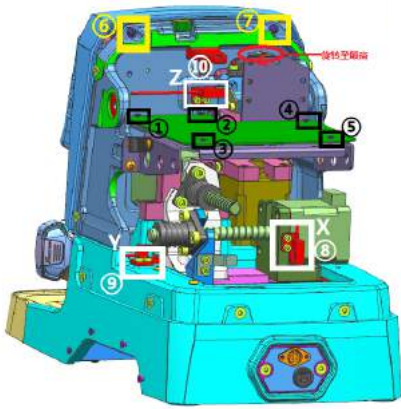

P5

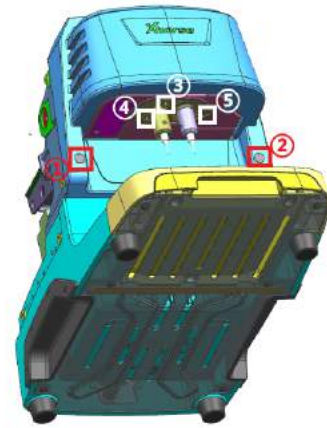

P6

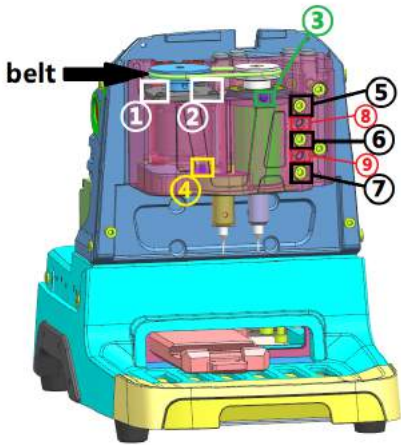

P7

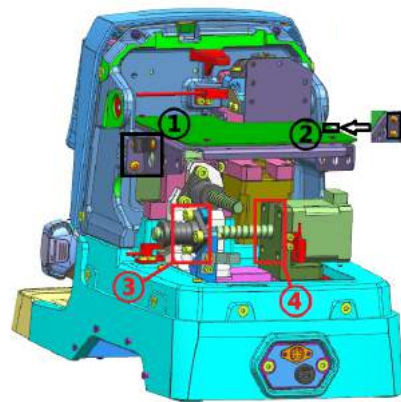

P8



P9



P10

## 2 Method of replacing parts due to machine malfunction

### 2.1 Replace the battery

Please refer to the disassembly pictures **P1, P2, P3, and P4** in Chapter 1. Remove the screws in the **red frame** separately to replace the battery module with a new one, and plug in the three wiring ports of the battery accordingly.

### 2.2 Replace the mainboard

Reason of replacement: **1.** The cutter non-conductive **2.**Unable to charge **3.**Unable to power on or upgrade. **4.** LED light does not light up **5.**Startup error **6.**cutting error.

Please refer to the disassembly pictures **P1 and P2** in Chapter 1. Remove the screws in the **black frame** to remove the rear cover. Then refer **P5** to remove the screws at **position Z of the white frame at ⑩**, and then remove the screws in the **black frame at ① to ⑤** separately to replace the mainboard with a new one. Insert the mainboard port according to the wire harness label.

### 2.3 Replace the screen

Please refer to the disassembly pictures **P1 and P2** in Chapter 1. Remove the screws in the **black frame** separately to remove the rear cover and screen, then remove the screws in the **white frame**, as shown in the following picture, remove the wires in the circle, then push out the bracket that fixes the screen, and finally remove the plastic pins from the screen harness, then you can separate the screen from the back rover.

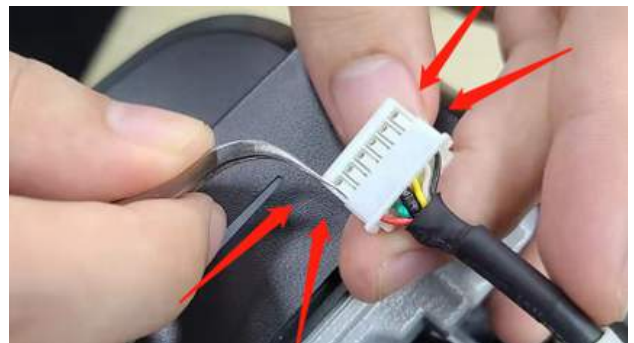
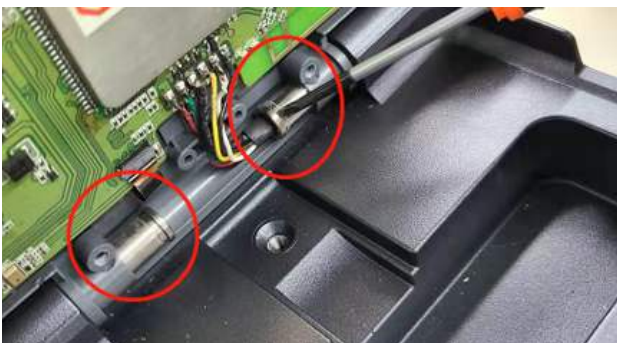



## 2.4 Replace the spindle motor belt

Due to long-terms use, the belt should be replaced in a timely manner when it ages, breaks or slips (breaking the cutter during cutting). Refer to **P1 and P2** in Chapter 1, remove the screws in the **black frame** to remove the rear cover, then refer **P5** to remove the screws in the **yellow frame at ⑥⑦**, and then rotate the **Z-axis in the red circle clockwise** to its highest position, then refer **P6** to remove the screw from the **red frame at ①②** to remove the front cover and screen and replace them. Then refer **P7** to replace the belt. Insert the mainboard port according to the wire harness label.

## 2.5 Replace the motor

### 2.5.1 Replace the spindle motor

When the motor makes abnormal noise, it needs to be replaced. Refer **chapter 2.4** to remove the front cover and belt, then refer **P7** to remove the screws in the **white frame at ①②** and **green frame at ③**, after that, replace it directly.

### 2.5.2 Replace the X-axis screw shaft motor

When the screw motor gets stuck or bent, **the X-axis screw shaft motor** need to replace. Refer to the disassembly pictures **P1 and P2**, remove the screws in their **black frame** separately to remove the rear cover, refer **P8** to remove the screws in the **red frame at ③④**, after that, replace it directly.

Replace the **x-axis rail** need to refer to **chapter 2.1**. Remove the battery first, then refer **P9** to remove the screws in the **black frame at ①**, then remove screws in the **red frame at ②** and the **white screws at ③④**, after that, replace it directly.

### 2.5.3 Replace the Y-axis screw shaft motor

When the screw motor gets stuck or bent, **the Y-axis screw shaft motor** need to replace. Refer **chapter 2.2** to remove the mainboard first, then refer **P8** to remove the screws in the **black frame at ①②** and the **red frame at ③④**, refer **chapter 2.5.2** to remove **the X-axis screw shaft motor first**, then refer **P10** to remove the screws in the **black frame at ①**, remove the screws in the **red circle** in the right picture , then replace the Y-axis screw shaft motor directly.

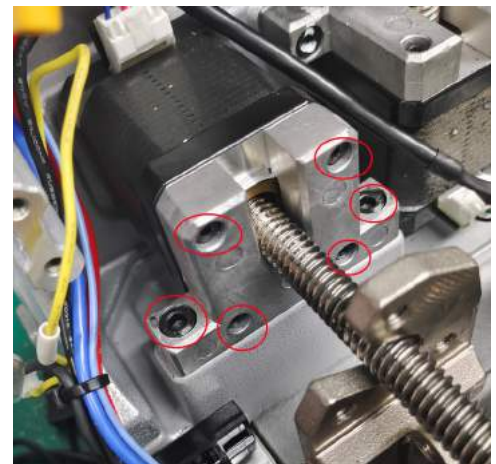

### 2.5.4 Replace the Z-axis screw shaft motor

When the screw motor gets stuck or bent, **the Z-axis screw shaft motor** need to replace. Refer to the **chapter 2.2** to remove the mainboard first, refer **P8** to remove the screws in the **black frame at ①②**, then refer **P10** to remove the screw in the **white frame at ②③**, then replace the Z-axis screw shaft motor directly.

## 2.6 Replace the sensor

### 2.6.1 Replace the X-axis sensor

When the sensor is defective or damaged, it needs to be replaced. Please refer **P1 and P2** to remove the screws in the **green frame** and remove the rear cover, then refer **P5** to remove the screws at position X in the **white frame** at ⑧, then replace it. Insert the mainboard port according to the wire harness label.

### 2.6.2 Replace the Y-axis sensor

When the sensor is defective or damaged, it needs to be replaced. Please refer **P1 and P2** to remove the screws in the **green frame** and remove the rear cover, then refer **P5** to remove the screws at position Y in the **white frame** at ⑨, then replace it. Insert the mainboard port according to the wire harness label.

### 2.6.3 Replace the Z-axis sensor

When the sensor is defective or damaged, it needs to be replaced. Please refer **P1 and P2** to remove the screws in the **green frame** and remove the rear cover, then refer **P5** to remove the screws at position Z in the **white frame** at ⑩, then replace it. Insert the mainboard port according to the wire harness label.

## 2.7 Replace or inspect the probe wires

### 2.7.1 The probe non-conductive

Poor contact or broken circuit caused by worn probe wires. Refer **chapter 2.3** to remove the front cover and belt, then refer **P7** to remove the **green frame** at ③, refer **P6** to remove the **white frame** at ③④⑤. As shown in the left picture below, **gently** pull the red probe wire forward while shaking the probe base. Then in the right picture below, you can see the screw which fixed probe **in the red frame**, unscrew it to replace the probe and cutting wires. Insert the mainboard port according to the wire harness label.

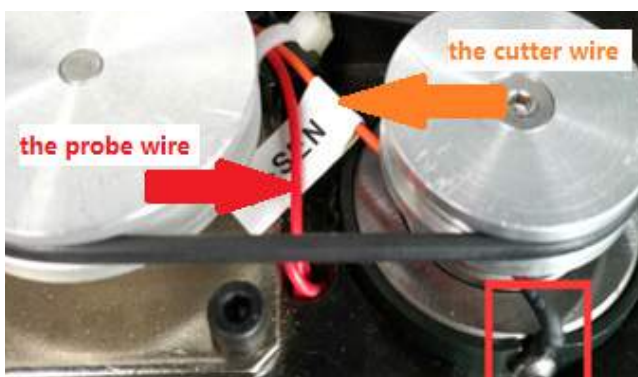

### 2.7.2 The probe remains conductive

Refer to **chapter 2.7.1**, check if the probe wire is broken, and if there are metal debris near the fixing screws or at the lamp panel (don't blow with an air gun)

## 2.8 Replace or inspect the cutter wires

### 2.8.1 The cutter non-conductive

Poor contact or broken circuit caused by worn probe wires, refer **chapter 2.7.1** to replace the probe and cutting wires. Insert the mainboard port according to the wire harness label.

### 2.8.2 The cutter remains conductive

Refer to **chapter 2.7.1**, check if the cutter wire is broken, and if there are metal debris near the fixing screws or at the lamp panel (don't blow with an air gun).

If none of the above situation exist, the cutter remains conductive, refer **P7** to **loosen** the screws in the **black frame at ⑤⑥⑦**, and **tighten** the screws in the **red frame at ⑧⑨**, use your fingers to push the cutter hole upwards slowly, then observe if the **white insulation paper** is

broken or if there are metal debris inside the cutting shaft (Don't blow with an air gun), refer to the picture on the right. when reinstalling the screws, it is necessary to refer **P7** to loosen the screws in the **red frame at ⑧⑨** first.

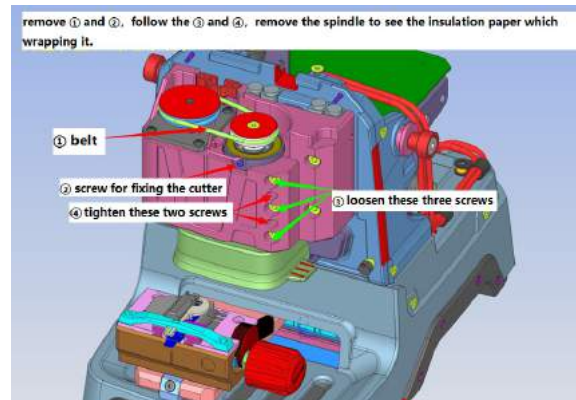

## 2.9 Replace the probe shaft or the cutter shaft

When the top thread of the probe and the cutter is slippery and cannot be removed, it is necessary to replace the **probe shaft** or the cutter shaft. Replace the probe shaft needs to refer **chapter 2.7.1** and replace the probe base. Replace the cutter shaft needs to refer **chapter 2.8** and remove the cutter shaft, then refer **chapter 2.10** to disassemble it.

## 2.10 Main shaft abnormal noise maintenance

Reason for abnormal noise: metal debris present, belt wear and large gap in the shaft hole for the cutter. Refer **chapter 2.3** to remove the front cover, clean the metal debris, replace the belt, or refer **P7** to **loosen** the screws in the **red frame at ⑧⑨**, and **tighten** the screws in the **black frame at ⑤⑥⑦**.

The disassembly and assembly of the spindle structure are as follows:





## 2.11 Replace the key switch and USB port

Replace the **key switch** needs to refer the **P1 and P2** and remove the screws in the **black frame**, and remove the rear cover, then refer to the picture on the right, remove the screws securing the switch on the rear cover in the green frame, then replace it.

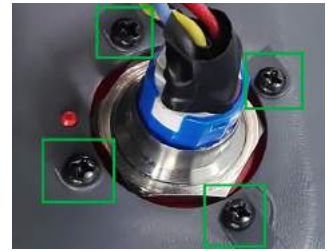

Replace the **fuse** need to refer to the picture on the right, on the back of the machine, remove the screws in the **red frame**, and rotate it out to replace it.



## 2.12 Replace clamp parts

**M2 clamp:** Rotate the knob outward on the left picture, then it can be disassembled. Replace the corresponding parts according to the picture on the right.

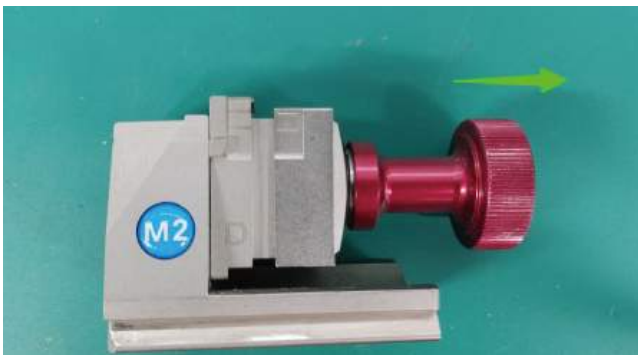

**Note:** M2 clamp needs to pay attention to the **gaps** in the fright figure , align it before tightening, Otherwise, it may get stuck.

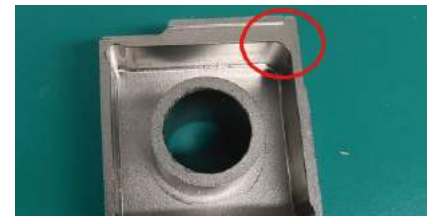

**M5 clamp:** Remove the nut in the **white frame** and remove the screws in the **red frame** on the picture below, rotate the knob outward on the left picture, then it can be disassembled. Replace the corresponding parts according to the picture on the right.

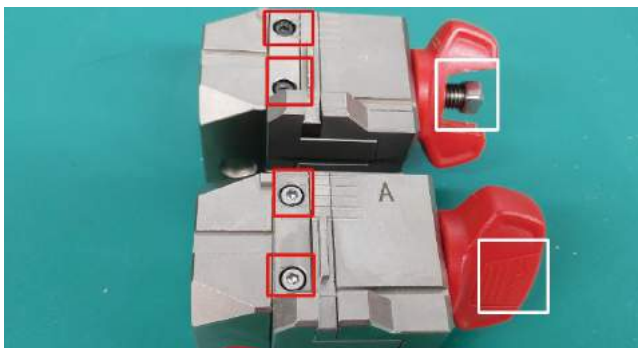





Shenzhen Xhorse Electronics Co.,Ltd

Address:2801-2805, 2901-2905, Block A, Building 6, Shenzhen International Innovation Valley, Dashi 1st Road, Xili community, Nanshan District, Shenzhen

---