

Copyright Information

Copyright © 2023 by LAUNCH TECH. CO., LTD (also called LAUNCH for short). All rights reserved. No part of this publication may be reproduced, stored in a retrieval system, or transmitted in any form or by any means, electronic, mechanical, photocopying, recording or otherwise, without the prior written permission of LAUNCH.

Statement: LAUNCH owns the complete intellectual property rights for the software used by this product. For any reverse engineering or cracking actions against the software, LAUNCH will block the use of this product and reserve the right to pursue their legal liabilities.

Disclaimer of Warranties and Limitation of Liabilities

All information, illustrations, and specifications in this manual are based on the latest information available at the time of publication.

The right is reserved to make changes at any time without notice. We shall not be liable for any direct, special, incidental, indirect damages or any economic consequential damages (including the loss of profits) due to the use of the document.

Using This Manual

This manual contains device usage instructions.

Some illustrations shown in this manual may contain modules and optional equipment that are not included in your system.

The following conventions are used.

Bold Text

Bold text is used to highlight selectable items such as buttons and menu options.

Example:

Tap **OK**.

Notes and Important Messages

Notes

A NOTE provides helpful information such as additional explanations, tips, and comments.

Example:

 Note: Remember to remove the VCI connector from the vehicle's DLC after use.

Warning

Warning indicates a hazardous situation which, if not avoided, could result in minor or moderate injury to the operator or to bystanders.

Example:

 Warning: Retrieving and using DTCs for troubleshooting vehicle operation is only one part of an overall diagnostic strategy. Never replace a part based only on the DTC definition. Each DTC has a set of testing procedures, instructions and flow charts that must be followed to confirm the location of the problem. This information can be found in the vehicle's service manual.

Danger

Danger indicates an imminently or potentially hazardous situation which, if not avoided, could result in death or serious injury to the operator or to bystanders.

Example:

 Danger: If you must drive the vehicle in order to perform a troubleshooting procedure, always have a second person help you. Trying to drive and operate the diagnostic tool at the same time is dangerous, and could cause a serious traffic accident.

Illustrations

Illustrations used in this manual are samples, the actual testing screen may vary for each vehicle being tested. Observe the menu titles and on-screen instructions to make correct option selection.

Important Safety Precautions

To avoid personal injury, property damage, or accidental damage to the product, read all of the information in this section before using the tool.

DANGER

- When an engine is operating, keep the service area well-ventilated or attach a building exhaust removal system to the engine exhaust system. Engines produce various poisonous compounds (hydrocarbon, carbon monoxide, nitrogen oxides, etc.) that cause slower reaction time and result in death or serious personal injury.
- Please use the included battery and power adaptor. Risk of explosion if the battery is replaced with an incorrect type.
- DO NOT attempt to operate the tool while driving the vehicle. Have second personal operate the tool. Any distraction may cause an accident.

WARNING

- Always perform automotive testing in a safe environment.
- Do not connect or disconnect any test equipment while the ignition is on or the engine is running.
- Before starting the engine, put the gear lever in the Neutral position (for manual transmission) or in the Park (for automatic transmission) position to avoid injury.
- NEVER smoke or allow a spark or flame in vicinity of battery or engine. Do not operate the tool in explosive atmospheres, such as in the presence of flammable liquids, gases, or heavy dust.
- Keep a fire extinguisher suitable for gasoline/chemical/electrical fires nearby.
- Wear an ANSI-approved eye shield when testing or repairing vehicles.
- Put blocks in front of the drive wheels and never leave the vehicle unattended while testing.
- Use extreme caution when working around the ignition coil, distributor cap,

LAUNCH

ignition wires and spark plugs. These components create hazardous voltage when the engine is running.

- To avoid damaging the tool or generating false data, please make sure the vehicle battery is fully charged and the connection to the vehicle DLC (Data Link Connector) is clear and secure.
- Automotive batteries contain sulfuric acid that is harmful to skin. In operation, direct contact with the automotive batteries should be avoided. Keep the ignition sources away from the battery at all times.
- Keep the tool dry, clean, free from oil, water or grease. Use a mild detergent on a clean cloth to clear the outside of the equipment when necessary.
- Keep clothing, hair, hands, tools, test equipment, etc. away from all moving or hot engine parts.
- Store the tool and accessories in a locked area out of the reach of children.
- Do not use the tool while standing in water.
- Do not expose the tool or power adapter to rain or wet conditions. Water entering the tool or power adaptor increases the risk of electric shock.
- This tool is a sealed unit. There are no end-user serviceable parts inside. All internal repairs must be done by an authorized repair facility or qualified technician. If there is any inquiry, please contact the dealer.
- Keep the tool far away from magnetic devices because its radiations can damage the screen and erase the data stored on the tool.
- Do not attempt to replace the internal rechargeable lithium battery. Contact the dealer for factory replacement.
- Do not disconnect battery or any wiring cables in the vehicle when the ignition switch is on, as this could avoid damage to the sensors or the ECU.
- Do not place any magnetic objects near the ECU. Disconnect the power supply to the ECU before performing any welding operations on the vehicle.
- Use extreme caution when performing any operations near the ECU or sensors. Ground yourself when you disassemble PROM, otherwise ECU and sensors can be damaged by static electricity.
- When reconnecting the ECU harness connector, be sure it is attached firmly, otherwise electronic elements, such as ICs inside the ECU, can be damaged.

FCC Statement

FCC ID: XUJX431PROV5

Note: This equipment has been tested and found to comply with the limits for a Class B digital device, pursuant to part 15 of the FCC Rules. These limits are designed to provide reasonable protection against harmful interference in a residential installation. This equipment generates, uses and can radiate radio frequency energy and, if not installed and used in accordance with the instructions, may cause harmful interference to radio communications. However, there is no guarantee that interference will not occur in a particular installation. If this equipment does cause harmful interference to radio or television reception, which can be determined by turning the equipment off and on, the user is encouraged to try to correct the interference by one or more of the following measures:

- Reorient or relocate the receiving antenna.
- Increase the separation between the equipment and receiver.
- Connect the equipment into an outlet on a circuit different from that to which the receiver is connected.
- Consult the dealer or an experienced radio/TV technician for help.

The device has been evaluated to meet general RF exposure requirement. The highest reported SAR for stand-alone and simultaneous transmission exposure conditions are below the maximum value. End-users must be informed of the operating requirements for satisfying RF exposure compliance.

This device is in compliance with the essential requirements and other relevant provisions of Radio Equipment Directive 2014/53/EU. The RF frequencies can be used in Europe without restriction.

TABLE OF CONTENTS

1 Introduction	1
1.1 Product Profile	1
1.2 Package List	2
1.3 Components & Controls	4
1.3.1 Display Tablet	4
1.3.2 VCI Connector	5
1.4 Technical Parameters	7
2 Initial Use	8
2.1 Charging & Turning On	8
2.2 Screen Layout	8
2.3 Basic Gestures	8
2.4 Change System Language	9
2.5 Adjust Brightness	9
2.6 Set Standby Time	9
2.7 Network Setup	10
3 Getting Started	11
3.1 Register & Update	11
3.2 Home Screen	13
4 Connections	15
4.1 Preparation	15
4.2 Vehicle Connection	15
5 Diagnosis	18
5.1 Intelligent Diagnose	18
5.2 Local Diagnose	21
5.2.1 Health Report (Quick Test)	24
5.2.2 System Scan	26
5.2.3 System Selection	27
5.3 Diagnostic History	35

5.4 Feedback	35
6 Service (Reset) Function.....	37
6.1 Maintenance Light Reset (Oil Reset).....	37
6.2 Electronic Parking Brake Reset (BRAKE RESET).....	37
6.3 Steering Angle Reset (SAS Reset).....	37
6.4 ABS Bleeding	38
6.5 Crank Position Sensor Adaptive Learning (GEAR LEARN).....	38
6.6 Anti-theft Matching (IMMO).....	38
6.7 Injector Coding (INJECTOR)	38
6.8 Battery Matching (BAT. RESET)	39
6.9 DPF Regeneration (DPF REG.).....	39
6.10 Throttle Matching (ELEC. THROTTLE RLRN).....	39
6.11 Gearbox Matching (GEARBOX)	39
6.12 Headlight Matching (AFS RESET).....	40
6.13 Sunroof Initialization (SUNROOF)	40
6.14 Suspension Level Calibration (SUS RESET).....	40
6.15 EGR Adaption	40
6.16 Seats Calibration	40
6.17 Tyre Reset.....	40
6.18 Coolant Bleed.....	40
6.19 AdBlue Reset (Diesel Engine Exhaust Gas Filter).....	40
6.20 NOx Sensor Reset.....	41
6.21 AC System Relearn/Initialization	41
6.22 High Voltage Battery Detection (HIGH VOLTAGE BATTERY)	41
6.23 Windows Calibration.....	41
6.24 Language Change	41
6.25 A/F Reset	41
6.26 Transport Mode	41
6.27 Stop/Start Reset	41
6.28 Intelligent Cruise Control System Reset	42

LAUNCH

6.29 Engine Power Balance Monitoring	42
6.30 Gas Particulate Filter (GPF) Regeneration	42
6.31 Motor Angle Calibration	42
7 Software Update	43
7.1 Update Diagnostic Software & APP	43
7.2 Update Frequently Used software	44
7.3 Renew Subscription.....	44
8 User Info.....	46
8.1 My Report.....	46
8.2 VCI	46
8.3 VCI Management	46
8.4 Activate VCI.....	46
8.5 Firmware Fix.....	46
8.6 My Order	47
8.7 Subscription Renewal Card	47
8.8 Profile	47
8.9 Change password.....	47
8.10 Settings	47
8.10.1 Units.....	47
8.10.2 Shop Information.....	47
8.10.3 Printer Set	47
8.10.4 Clear Cache	48
8.10.5 About.....	48
8.10.6 Login/Logout	48
8.11 Diagnostic Software Clear	48
9 Other Modules	49
9.1 Testable Models	49
9.2 Tablet Setting	49
9.3 Files.....	49
9.4 System OTA Upgrade	49

LAUNCH

9.5 Recording Master	49
9.6 Calculator	49
9.7 Browser	49
9.8 Gmail	50
9.9 Camera	50
9.10 Gallery	50
10 FAQ	51

1 Introduction

1.1 Product Profile

It inherits from LAUNCH's advanced diagnosing technology and is characterized by covering a wide range of vehicles, featuring powerful functions, and providing precise test result.

Through simple wireless/wired communication between VCI (Vehicle Communication Interface) device and the display tablet, it achieves full car model and full system vehicle trouble diagnosis, which include Reading DTCs, Clearing DTCs, Reading Data Stream, Actuation Test and Special Functions.

It has the following features:

- **Intelligent Diagnose**: This module allows you to use the VIN information of the currently identified vehicle to access its data (including vehicle information, historical diagnostic records) from the cloud server to perform quick test, eliminating guesswork and step-by-step manual menu selection.
- **Local Diagnose**: Follow the on-screen prompts to start diagnostic session step by step.
- **Service Function**: It offers coding, reset, relearn and more service functions, to help vehicles get back to functional status after repair or replacement. Available tests vary by vehicle manufacturer, year, and model.
- **One-click Update**: Lets you update your diagnostic software online.
- **Mall**: Enables you to subscribe some extra software or service functions that are not integrated in the tool online.
- **Diagnostic History**: This function provides a quick access to the tested vehicles and users can choose to view the test report or resume from the last operation, without starting from scratch.
- **Feedback**: Enables you to submit the vehicle issue to us for analysis and troubleshooting.
- **Testable Models**: Quick dial to view the vehicle models that the tool covers.

1.2 Package List

The following packing list is for reference purpose only. For different destinations, the accessories may vary. For details, please consult from the seller or check the packing list supplied with this tool together.

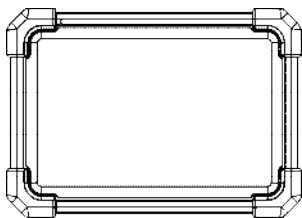

Display tablet x 1

Indicates the test result.

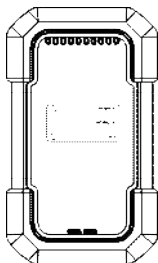

VCI connector x 1

A device for accessing vehicle live data.



Diagnostic cable x 1

Connects the VCI connector to vehicle's OBD II diagnostic socket.

It can be separated into two parts: HDB15F to HD15F data cable and HD15M to OBD II adaptor.



Password envelope x 1

A piece of paper bearing the product Serial Number and Activation Code for product registration.

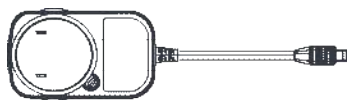

Power adaptor x 1 + Switching adaptors x 2

Charges the tablet via AC outlet.



Type-A to Type-C USB cable x 1

- Connects the diagnostic tool to AC outlet / PC for charging / data exchange.
- Connects the VCI connector to the diagnostic tool to perform vehicle diagnosis.



Quick Start Guide x 1

1.3 Components & Controls

There are two main components to the diagnostic system:

- Display Tablet – the central processor and monitor for the system (See Chapter 1.3.1).
- VCI Device – the device for accessing vehicle data (See Chapter 1.3.2).

1.3.1 Display Tablet

The tablet acts as the central processing system, which is used to receive and analyze the live vehicle data from the VCI device and then output the test result.

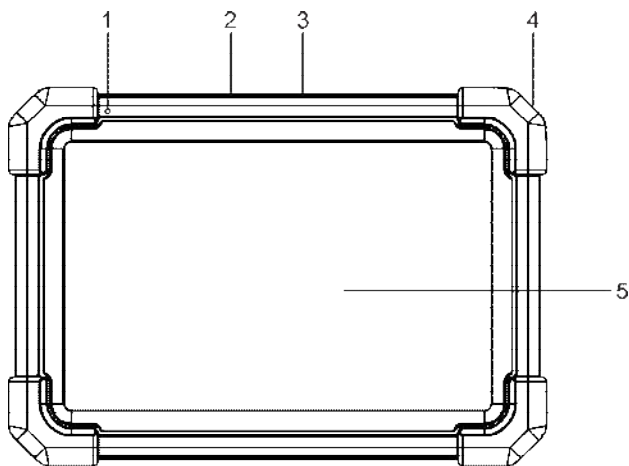

1. Microphone

2. Type-A USB Port

- Connect to the VCI connector to perform vehicle diagnosis via the USB cable.
- Connect to an external USB storage device for data exchange.

3. Type-C USB Port

- Connect to AC outlet for charging.
- Connect to PC for data exchange.

LAUNCH

4. POWER Key

- In Off mode, press it for 3 seconds to turn the tablet on.
- In On mode:
 - Press it once to activate the LCD if the LCD is off. Press it once to turn off the LCD if the LCD lights up.
 - Press and hold it for 3 seconds to turn it off.
 - Press and hold it for 8 seconds to perform forced shutdown.

5. LCD Screen

Indicate the test result.

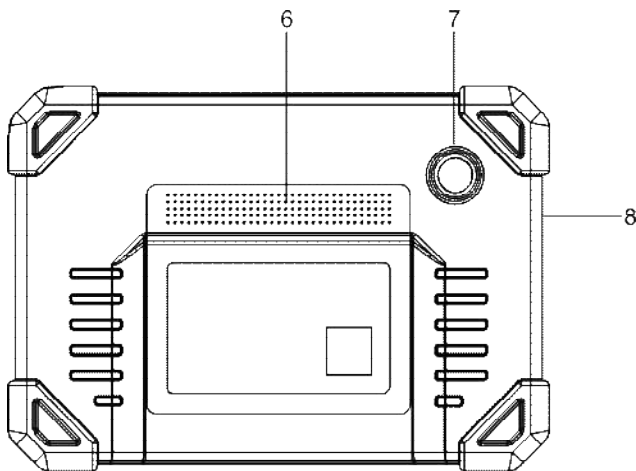

6. Speakers

7. Rear Camera

8. Microphone

1.3.2 VCI Connector

The VCI connector works as a vehicle communication interface device, which is used to connect to the vehicle's DLC (Data Link Connector) socket via the diagnostic cable to read the vehicle data and then send it to the tablet.

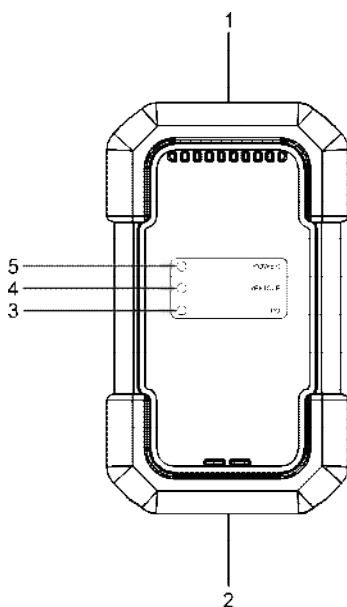

1. OBD-15 diagnostic connector

Connect on vehicle's OBD II DLC via the diagnostic cable.

2. USB port

Connect the VCI to the tablet to perform vehicle diagnosis via USB cable.

3. I/O indicator

- Illuminates blue when the VCI is communicating with the tablet wirelessly.
- Illuminates red when the VCI is connected to the tablet via USB cable.

4. VEHICLE indicator

Illuminates green and flashes when the VCI is communicating with the vehicle.

5. POWER indicator

Illuminates solid red while the VCI is powered up.

1.4 Technical Parameters

Display Tablet

Operating system: Android

Memory: 4GB

Storage: 64GB

Screen: 7 inch capacitive touch screen with a resolution of 1024 x 600 pixels

Camera: Rear-facing 8.0MP camera

Connectivity:

- Wi-Fi (802.11a/b/g/n/ac)
- Bluetooth

Working temperature: 0°C ~ 50°C

Storage temperature: -20°C ~ 70°C

VCI Connector

Working voltage: 9 ~18V

Power consumption: $\leq 2.0W$

Dimension: 118.3mm*69.5mm*32mm

Working temperature: 0°C ~ 50°C

Relative humidity: 20% ~ 90%

2 Initial Use

2.1 Charging & Turning On

1. Use the included power adaptor to charge the tablet.
2. After charging is complete, press the **POWER** button to turn the tablet on. The system starts initializing and then enters the home screen.

 Note: If the battery remains unused for a long period of time or the battery is completely discharged, it is normal that the tool will not power on while being charged. Please charge it for a period of 5 minutes and then turn it on.

 Warning: Please use the included power adaptor to charge your tool. No responsibility can be assumed for any damage or loss caused as a result of using power adaptors other than the one supplied.

Press the **POWER** button for 3 seconds, an option menu will pop up on the screen. Tap **Power off/Restart** to turn it off/reboot it.

2.2 Screen Layout

There are five on-screen buttons available on the bottom of the screen.



Home: Navigates to the Android's home screen.



Recent App: Views the running applications.



VCI Connection: Shows whether the VCI device is properly connected or not. If displayed in green, it indicates the communication between the tablet and the VCI is established.



Screenshot: Captures the current screen.



Back: Returns to the previous screen.

2.3 Basic Gestures



Single-tap: To select an item or launch a program.

LAUNCH



Double-tap: To zoom in so that the text on a webpage appears in a column that fits your tablet's screen.



Long press: Tap and hold on the current interface or area until a contextual menu pops up on the screen, and then release it.



Slide: To jump to different pages.

2.4 Change System Language

The tool supports multiple system languages. To change the language of the tool, please do the following:

1. On the home screen, tap **Other Modules -> Settings -> System -> Language & input -> Languages**.
2. Tap **Add a language**, and then choose the desired language from the list.
3. Tap and hold the desired language and drag it to the top of the screen and then release it, the system will change into the target language.

2.5 Adjust Brightness



Note: Reducing the brightness of the screen is helpful to conserve the battery power.

1. On the home screen, tap **Other Modules -> Settings -> Display -> Brightness level**.
2. Drag the slider to adjust it.

2.6 Set Standby Time

If no activities are made within the defined standby period, the screen will be locked automatically and the system enters sleep mode to save power.

1. On the home screen, tap **Other Modules -> Settings -> Display -> Advanced -> Sleep**.

2. Choose the desired sleep time.

2.7 Network Setup

The tablet has built-in Wi-Fi that can be used to get online. Once you're online, you can register your tool, surf the Internet, get apps, and check for software updates etc.

1. On the home screen, tap **Other Modules -> Settings -> Network & Internet -> WLAN**.
2. Slide the Wi-Fi switch to ON, the tablet starts searching for available wireless networks.
3. Select a wireless network,
 - If the chosen network is open, the tablet will connect automatically.
 - If the selected network is encrypted, a network password will need to be entered.
4. When **Connected** appears, it indicates the Wi-Fi connection is complete.

 Note: When Wi-Fi is not required, this should be disabled to conserve battery power.

3 Getting Started

For new users, you will need to experience a user registration process before getting started.

3.1 Register & Update

Follow the steps below to sign in and update:

Tap **Login** on the upper right corner of the home screen, the following login window will pop up.

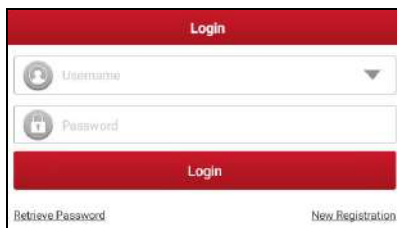

(If you are a new user, follow **A** to proceed.)

(If you have registered to be a member, go to **B** to login the system directly.)

(In case you forgot password, refer to **C** to reset a new password.)

A. If you are a new user, tap **New Registration** to enter the sign-up page.

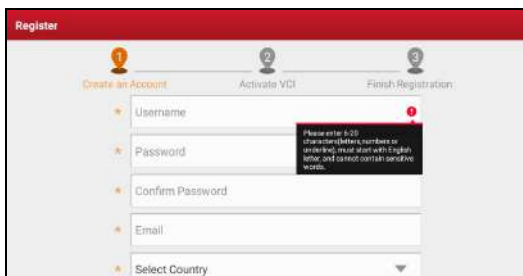

Fill in the information in each field (Items with * must be filled). After inputting, tap **Register**, the following screen will appear:

LAUNCH

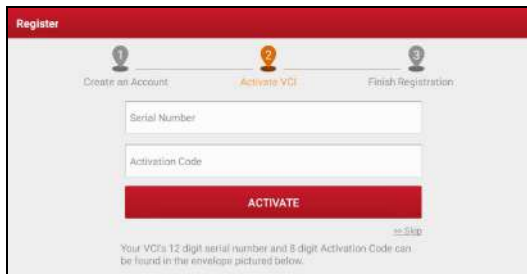

Input the 12-digit Product Serial Number and 8-digit Activation Code (can be obtained from the password envelope), and then tap **Activate**.



Tap **OK** to navigate to the update center to update all available software. Refer to Chapter 7 for detailed operations.

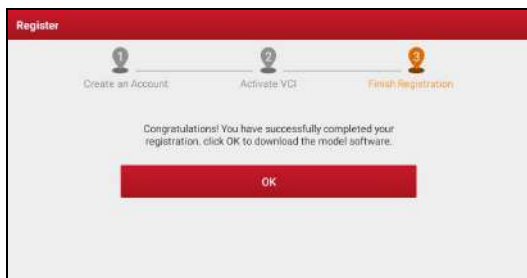

After the registration is successfully complete, the wireless communication between the tablet and the VCI device is automatically established and user has no need to configure it again.

LAUNCH

B. If you have registered to be a member, input your name and password, and then tap **Login** to enter the main menu screen directly.



Note: The tablet has an auto-save function. Once the username and password are correctly entered, the system will automatically store it. Next time you login the system, you will not be asked to input the account manually.

C. If you forgot the password, tap **Retrieve password** and then follow on-screen instructions to set a new password.

3.2 Home Screen

It mainly includes the following items:

Name	Description
Intelligent Diagnose	<ul style="list-style-type: none">Obtain vehicle data from the cloud server to perform quick test via reading VIN, to avoid various defects resulting from step-by-step menu selection.Check the historical repair records online.
Local Diagnose	Diagnose a vehicle manually.
Software Update	Update vehicle diagnostic software and APK.
Diagnostic History	<ul style="list-style-type: none">Access the diagnostic reports from the previously tested vehicles.Resume the previous operation without starting from scratch.
Feedback	Feedback the recent 20 diagnostic logs for issue analysis.
Service Function	It offers coding, reset, relearn and more service functions, to help vehicles get back to functional status after repair or replacement.
Mall	Subscribe some extra software or service functions that are not included in the diagnostic tool online.
Maintenance	Abundant maintenance data are available, which helps

LAUNCH

	repair professionals diagnose and repair vehicles efficiently, accurately and profitably.
User Info	To manage VCI, my reports, change password, configure Wi-Fi printer, make system settings and logout etc.
Other Modules	Includes testable models, product manual, FAQ and some commonly used system apps etc.

4 Connections

4.1 Preparation

- The vehicle ignition is turned on.
- The vehicle battery voltage range is 11-14 volts.
- The throttle is in the closed position.
- Find DLC location.

The DLC(Data Link Connector) is usually located 12 inches from the center of the instrument panel, under or around the driver's side for most vehicles. For some vehicles with special designs, the DLC location may vary. Refer to the following figure for location.

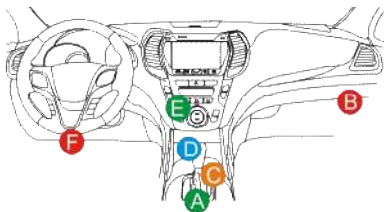

- A. Opel, Volkswagen, Audi
- B. Honda
- C. Volkswagen
- D. Opel, Volkswagen, Citroen
- E. Changan
- F. Hyundai, Daewoo, Kia, Honda, Toyota, Nissan, Mitsubishi, Renault, Opel, BMW, Mercedes-Benz, Mazda, Volkswagen, Audi, GM, Chrysler, Peugeot, Regal, Beijing Jeep, Citroen and other most popular models

If the DLC cannot be found, refer to the vehicle's service manual for the location.

4.2 Vehicle Connection

The method used to connect the VCI device to a vehicle's DLC depends on the vehicle's configuration as follows:

- A vehicle equipped with an OBD II management system supplies both

LAUNCH

communication and 12V power through a standardized DLC.

- A vehicle not equipped with an OBD II management system supplies communication through a DLC connection, and in some cases supplies 12V power through the cigarette lighter receptacle or a connection to the vehicle battery.

1. For OBDII vehicles, use the included diagnostic cable (HDB15F to HD15F data cable + HD15M to OBD II adaptor) to connect the VCI to the vehicle's DLC port.

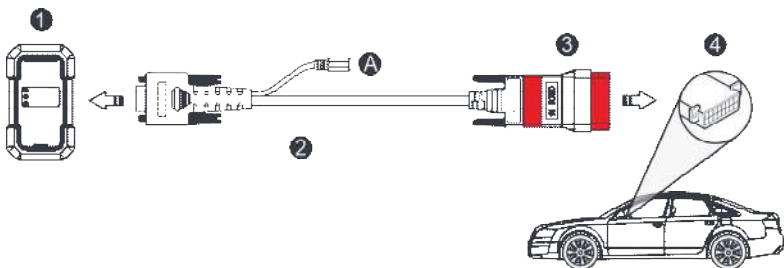

1. VCI
2. HDB15F to HD15F data cable
3. HD15M to OBD II adaptor
4. Vehicle's DLC port

2. For non-OBDII vehicle, refer to the above figure to make connection.

1. Select the appropriate adaptor from the non-16pin adaptor kit (sold separately) according to the vehicle's DLC port type (4).
2. Loosen the captive screws of the HDB15F to HD15F data cable (2) and disconnect the HD15M to OBD16 adaptor (3) from the data cable.
3. Connect the data cable (2) with the target adaptor on the above figure and tighten the screws. Other steps shall also apply.

 Note: If the pin of the DLC is damaged or has insufficient power, you can get power via either of the following methods:

A. Battery Clamps Cable (not included):

Connect one end of the battery clamps cable to the power jack of the diagnostic cable,

LAUNCH

and the other end to the vehicle's battery.

B. Cigarette Lighter Cable (not included):

Connect one end of the cigarette lighter cable to the power jack of the diagnostic cable, and the other end to the cigarette lighter receptacle.

If you choose to perform vehicle diagnosis via data cable, connect one end of the data cable into the VCI, and the other end into the USB port of the tablet.

5 Diagnosis

5.1 Intelligent Diagnose

Through simple wireless communication between the display tablet and VCI, you can easily get the VIN (Vehicle Identification Number) information of the currently identified vehicle. Once the VIN is successfully identified, the system will retrieve it from the remote server and then guide you to vehicle information page without step-by-step manual menu selection.

The vehicle information page lists all historical diagnostic records of the vehicle, which lets the technician have a total command of the vehicle faults. In addition, a quick dial to local diagnose and diagnostic function are also available on this page for reducing the roundabout time and increasing productivity.

Notes:

- Before using this function, please make sure the VCI is properly connected to the vehicle's DLC. For detailed connection, see Chapter 4.2 "Vehicle Connection".

- A stable network connection is required for this function.

1. Tap **Intelligent Diagnose** on the Home screen to start pairing with the VCI.

2. After pairing is complete, the tablet starts reading the vehicle VIN.

A. If the VIN can be found from the remote server database, the following screen will appear:



- Tap **Diagnostic** to start a new diagnostic session.
- Tap **Scan History** to view its historical repair record. If there are records available, it will be listed on the screen in sequence of date. If no records exist, the screen will show "No Record".

LAUNCH



- Tap **View Record** to view the details of the current diagnostic report.
- To perform other functions, tap **Quick access** to directly go to the function selection screen. Choose the desired one to start a new diagnostic session.

B. If the tablet failed to access the VIN information, the following screen will appear:

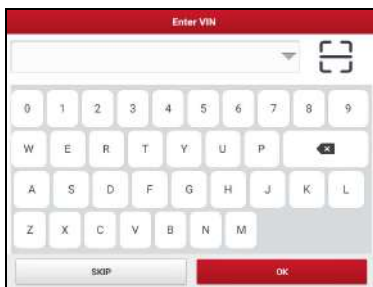





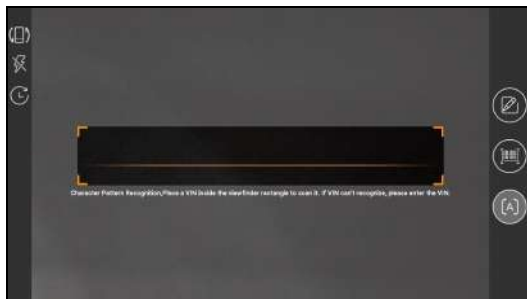

- Tap the input field to directly, tap **OK**. If the VIN exists on the remote server, the system will enter the diagnostic function selection screen.
- Tap  to launch the VIN recognition module.

LAUNCH



Place the VIN inside the viewfinder rectangle to scan it. The most recognizable location for this number is in the top left corner on the vehicle's dashboard. Other locations include the driver's door or post, and the firewall under the hood.

- Tap  to switch the display mode of the screen.
- Tap  to turn the camera flash on.
- Tap  to choose it from the record list if the VIN of the vehicle has been scanned before.
- Tap  to input the VIN manually if the tablet has failed to identify the VIN of the vehicle.
- Tap  to scan the VIN barcode. If the VIN barcode cannot be recognized, please manually input the VIN.
- Tap  to scan the VIN character. If the VIN character cannot be recognized, please manually input the VIN.

After scanning, the screen will automatically display the result.

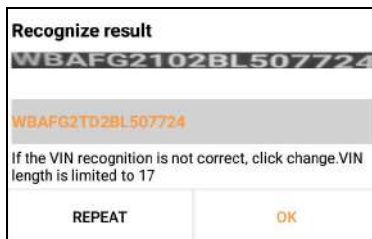

- If the VIN scanned is incorrect, tap the result field to modify it and then tap

LAUNCH

OK.

- To scan it again, tap **REPEAT**.

If the VIN exists on the remote server, the system will enter the diagnostic function selection screen.

5.2 Local Diagnose

In this mode, you need to execute the menu-driven command and then follow the on-screen instruction to proceed.

Tap **Local Diagnose** to enter the vehicle selection page.



Function Buttons:

All: Tap to view all vehicle models that the tablet covers.

Common: Tap to create a commonly used diagnostic software list or delete certain software from the list.

American/European/Asian/Chinese: Display all American/European/Asian/Chinese vehicle brands only.

DEMO: A simulation program for training purpose only.

ASTON MARTIN and other brands: Enhanced diagnostic program with manufacture proprietary information.

Take Demo (Version 15.32) as an example to demonstrate how to diagnose a vehicle.

- 1). **Select diagnostic software version:** Tap **DEMO** to go to Step 2.



On-screen Buttons:

Vehicle Coverage: Tap to view the vehicle models that the current diagnostic software covers.

What's new: Tap to view the optimized items and enhancements.

Introduction: Tap to check the software function list.

Note: Tap to read some precautions on using the current diagnostic software.

Search Bluetooth: Tap to search for the available VCI. After the VCI is successfully activated, it will be bound to the user account and paired with the tablet automatically.

 Note: No Bluetooth connection is required for DEMO program.

OK: Tap to go to next step.

The diagnostics toolbar contains a number of buttons that allow you to print the displayed data or make other controls. It is displayed on the upper right corner of the screen and goes through the whole diagnostic session. Below provides a brief description for the operations of the diagnostics toolbar buttons:

 **Home:** Returns to Home screen.

 **Print:** Tap to print the current screen. Before printing, you need to configure the wireless printer. Refer to Chapter 8.10.3.

 **Exit:** Exits the diagnostic application.

2). **Select vehicle model (varies with different versions):** Select the desired vehicle model. Here we take **Ford** for example to demonstrate how to diagnose a vehicle.

LAUNCH

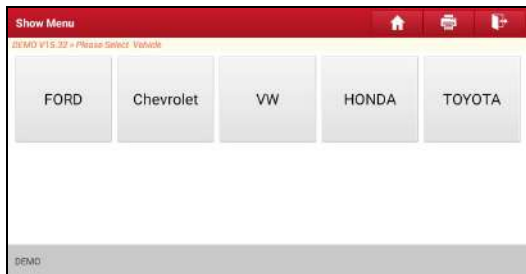

- 3). Turn the ignition key to ON: Set the ignition switch to on.



- 4). Read vehicle information: After reading the vehicle information, double check if the vehicle information is correct or not. If yes, tap **Yes** to continue.

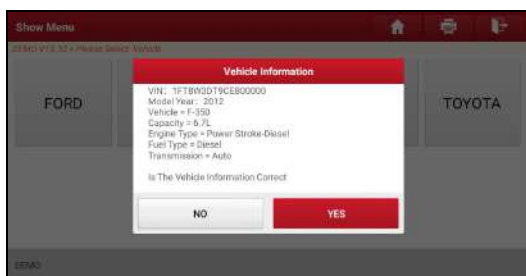

- 5). Select test item: Select the desired test item to proceed.

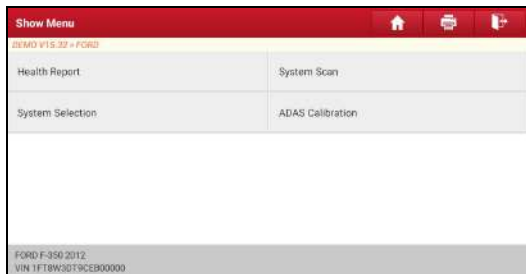

5.2.1 Health Report (Quick Test)

This function varies from vehicle to vehicle. It enables you to quickly access all the electronic control units of the vehicle and generate a detailed report about vehicle health.

On the test item selection screen, tap **Health Report** and turn on the ignition switch, the system will start scanning the ECUs. Once the scanning process is complete, the following screen will appear:



The tested system with fault code appears in red and the system functioning properly displays in black (normally).

 Note: Diagnostic Trouble Codes or Fault Codes can be used to identify which engine systems or components that are malfunctioning. Never replace a part based only on the DTC definition. Retrieving and using DTCs for troubleshooting vehicle operation is only one part of an overall diagnostic strategy. Follow testing procedures (in vehicle's service manual), instructions and flowcharts to confirm the locations of the problem.

On-screen Buttons:

LAUNCH

Enter: Tap to enter the diagnostic function selection screen.

(Search): Highlight certain diagnostic trouble code and tap it to retrieve it in the search engine.

Report: Tap to save the diagnostic result as a health report.



Report Information

Report Type
Pre-Repair

Vehicle Information
FORD F-350
2012 35565 km
1FT8W3D19CEB0000 License #
0

Report info

OK

 Note: Diagnostic report is classified into three categories: Pre-Repair report, Post-Repair report and Diagnostic Scan. No matter which type you saved the report as, the report type will be appended as a tag on the upper right corner of the diagnostic report for easier identification.

Tap ▼ to select the report type from the option list and input the required information, and then tap **OK**.

 Note: To facilitate the comparison of the pre-repair and post-repair reports and get accurate test result, please make sure you saved the right type of the diagnostic report.

To save the report as a common diagnostic report, select **Diagnostic Scan**.

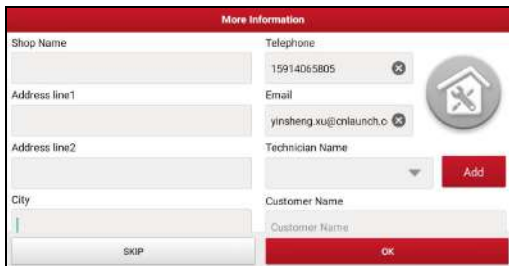

More information

Shop Name Telephone 15914065805

Address line1 Email yinsheng.xu@cnlaunch.com

Address line2 Technician Name Add

City Customer Name Customer Name

SKIP OK

 Note: For workshop information, tap the input box to enter it. Alternatively you can also set it in **User Info -> Settings -> Shop Information**.

LAUNCH

Once you configured the information, it will be automatically generated every time you saved the diagnostic report. All vehicle and workshop information will be appended as tags on the diagnostic report.

To ignore the workshop information, tap **Skip** to go to the report details screen.



On the report details screen, tap **Save** to save it. All diagnostic reports are saved in **Report -> Health Report**.

Help: Tap to view the help information of the selected DTC item.

Clear DTCs: Tap to clear the existing diagnostic trouble codes.

 Note: Clearing DTCs does not fix the problem(s) that caused the code(s) to be set. If proper repairs to correct the problem that caused the code(s) to be set are not made, the code(s) will appear again and the check engine light will illuminate as soon as the problem that cause the DTC to set manifests itself.

5.2.2 System Scan

This option allows you to quickly scan which systems are installed on the vehicle.

On the test item selection screen, tap **System Scan**, the system start scanning the systems. Once the scanning process is complete, the following screen will appear.



System Name	Result
PCM (Powertrain Control Module)	Equipped
TCM(Transmission Control Module)	Equipped
ABS(Anti-lock Braking System)	Equipped
RCM (Restraint Control Module)	Equipped
BCM(Body Control Module)	Equipped

FORD F-350 2012
VIN 1FT8W30T3C000000

Tap the desired system to go to the diagnostic function selection screen. For detailed operations on diagnostic function, please refer to Chapter 5.2.3.

5.2.3 System Selection

This option allows you to manually select the test system and function step by step.

On the test item selection screen, tap **System Selection**, the screen displays as follows:



PCM (Powertrain Control Module)	TCM(Transmission Control Module)
ABS(Anti-lock Braking System)	RCM (Restraint Control Module)
BCM(Body Control Module)	IMMO(Immobilizer)
APIM (Accessory Protocol Interface Module)	PAM (Parking Assist Module)
ICM1 (Information Center Module)	DDM (Driver Door Module)

FORD F-350 2012
VIN 1FT8W30T3C000000

Swipe the screen from the bottom to view the vehicle system on the next page.

Tap the target system (take **PCM** for example) to navigate to the diagnostic function selection screen.

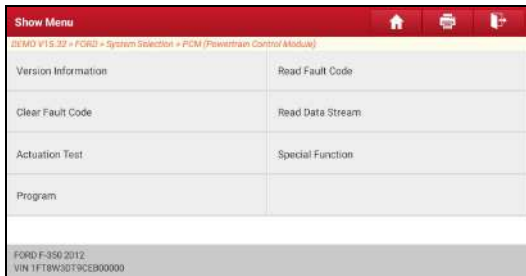

Note: Different vehicle has different diagnostic menus.

A. Version Information

This function is used to read the version information of system mode, vehicle VIN, software and ECU.

B. Read Fault Code

This function displays the detailed information of DTC records retrieved from the vehicle's control system.

 **Caution:** Retrieving and using DTCs for troubleshooting vehicle operation is only one part of an overall diagnostic strategy. Never replace a part based only on the DTC definition. Each DTC has a set of testing procedures, instructions and flow charts that must be followed to confirm the location of the problem. This information can be found in the vehicle's service manual.

On the diagnostic function selection screen, tap **Read Fault Code**, the screen will display the diagnostic result.

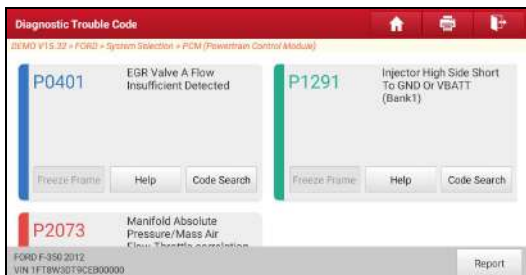

LAUNCH

On-screen Buttons:

Freeze Frame: When an emission-related fault occurs, certain vehicle conditions are recorded by the on-board computer. This information is referred to as freeze frame data. Freeze frame data includes a snapshot of critical parameter values at the time the DTC is set.

Help: Tap to view the help information.

Code Search: Tap to search for more information about the current DTC online.

Report: Tap to save the current data in text format. All reports are saved in **User Info -> My Report -> Diagnostic Report**.

C. Clear Fault Code

This function enables you to erase the codes from the vehicle after reading the retrieved codes from the vehicle and certain repairs have been carried out. Before performing this function, make sure the vehicle's ignition key is in the ON position with the engine off.

Clearing DTCs does not fix the problem(s) that caused the code(s) to be set. If proper repairs to correct the problem that caused the code(s) to be set are not made, the code(s) will appear again and the check engine light will illuminate as soon as the problem that cause the DTC to set manifests itself.

On the diagnostic function selection screen, tap **Clear Fault Code**, the following screen will appear.

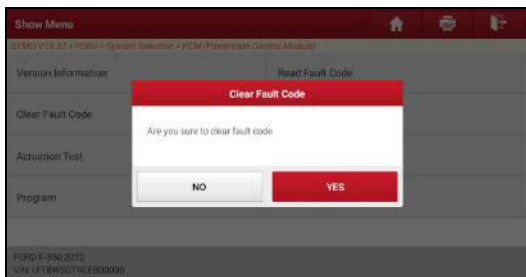

Tap **YES**, the system will automatically delete the currently existing trouble code.

 Note: After clearing, you should retrieve trouble codes once more or turn ignition

LAUNCH

on and retrieve codes again. If there are still some trouble codes in the system, please troubleshoot the code using a factory diagnosis guide, then clear the code and recheck.

D. Read Data Stream

This option lets you view and capture (record) real-time Live Data. This data including current operating status for parameters and/or sensor information can provide insight on overall vehicle performance. It can also be used to guide vehicle repair.

 **Caution:** If you must drive the vehicle in order to perform a troubleshooting procedure, ALWAYS have a second person help you. Trying to drive and operate the diagnostic tool at the same time is dangerous, and could cause a serious traffic accident.

 **Note:** The real time (Live Data) vehicle operating information (values/status) that the on-board computer supplies to the tool for each sensor, actuator, switch, etc. is called Parameter Identification Data (PID).

On the diagnostic function selection screen, tap **Read Data Stream**, the following screen will appear.

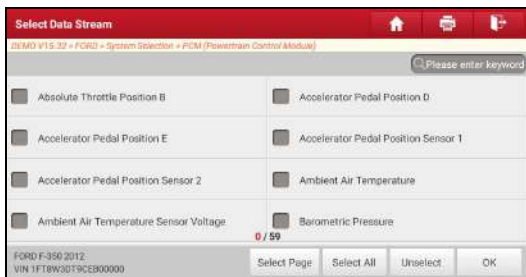

On-screen Buttons:

Select Page: Tap to select all items of the current page.

Select All: Tap to select all items. To select certain data stream item, just check the box before the item name.

Unselect: Tap to deselect all data stream items.

OK: Tap to confirm and jump to the next step.

After selecting the desired items, tap **OK** to enter the data stream reading page.

Name	Value	Standard Range	English	Metric
Absolute Throttle Position B	12.94	0 - 100	%	
Accelerator Pedal Position D	0	0 - 100	%	
Accelerator Pedal Position E	0	0 - 100	%	
Accelerator Pedal Position Sensor 1	0.78 (1 / 2)	0 - 5	V	

FORD F-350 2012
VIN 1FTRW031RC390000

Graph Report Record Help



Notes:

1. Tap English or Metric to switch the measurement unit.
2. If the value of the data stream item is out of the range of the standard (reference) value, the whole line will display in red. If it complies with the reference value, it displays in blue (normal mode).
3. The indicator 1/X shown on the bottom of the screen stands for the current page/total page number. Swipe the screen from the right/left to advance/return to the next/previous page.

There are 3 types of display modes available for data viewing, allowing you to view various types of parameters in the most suitable way.

- ✓ Value – This is the default mode which displays the parameters in texts and shows in list format.
- ✓ Graph – Displays the parameters in waveform graphs.
- ✓ Combine – This option is mostly used in graph merge status for data comparison. In this case, different items are marked in different colors.

On-screen Buttons:



Graph(Single): Tap to view the parameter in waveform graph.

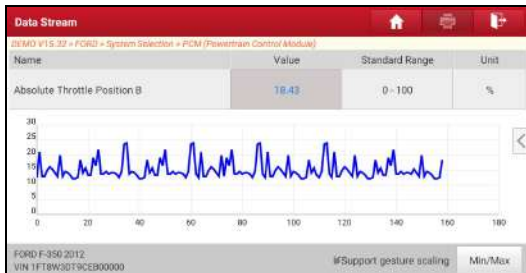

- **Min/Max:** Tap to define the maximum / minimum value. Once the value goes beyond the specified value, the system will alarm.

Graph: Tap to view the parameters in waveform graphs.

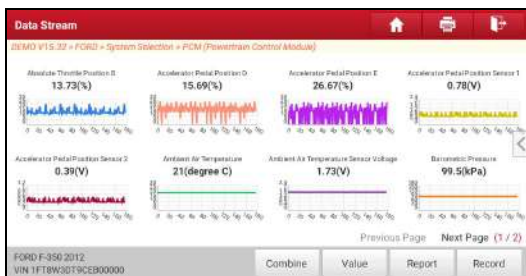

- **Combine:** This option is mostly used in graph merge status for data comparison. In this case, different items are marked in different colors (maximum 4 items can be displayed on the same screen simultaneously). If the graph is more than one page, swipe the screen from the left to jump to the next page.

LAUNCH



- **Value:** Switches the current graph display mode to the Value display mode.
- **Customize:** Tap , a pull-down list of the data stream items appears on the screen. Select / deselect the desired items, and then screen will display / remove the waveforms corresponding to these items immediately.

Report: Tap to save the current data in text format. All reports are saved in **User Info -> My Report -> Diagnostic Report**. For details on report operations, please refer to Chapter 8.1.

Record: Tap to start recording diagnostic data. Recorded live data can serve as valuable information to help you in troubleshooting of vehicle problems.

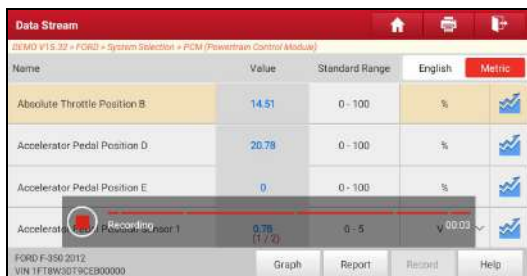

Tap  to end recording and save it. The saved file follows the naming rule: It begins with vehicle type, and then the product S/N and ends with record starting time (To differentiate between files, please configure the accurate system time).

All diagnostic records can be replayed from **User Info -> My Report -> Diagnostic Record**.

E. Actuation Test

This option is used to access vehicle-specific subsystem and component tests. Available test vary by vehicle manufacturer, year, and model.

During the actuation test, the display tablet outputs commands to the ECU in order to drive the actuators, and then determines the integrity of the system or parts by reading the ECU data, or by monitoring the operation of the actuators, such as switching an injector between two operating states.

On the diagnostic function selection screen, tap **Actuation Test**, the following screen will appear:



Simply follow the on-screen instructions and make appropriate selections to complete the test.

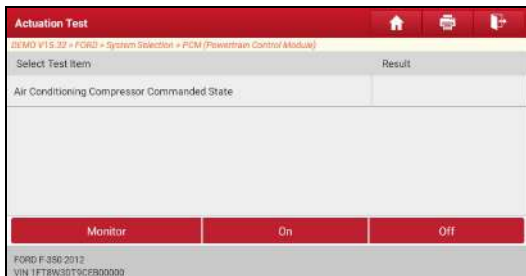

Each time when an operation is successfully executed, *Completed* displays.

5.3 Diagnostic History

This function enables users to directly get access to the previously tested vehicle's diagnostic records in details, so users can resume from the last operation, without starting from scratch.

Tap **Diagnostic History** on the Home screen, all diagnostic records will be listed on the screen in date sequence.

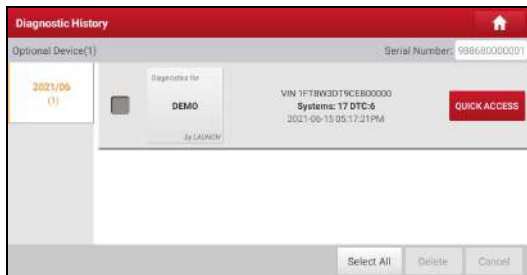

- Tap certain vehicle model to view the details of the last diagnostic report.
- To delete certain diagnostic history, select it and then tap **Delete**. To delete all historical records, tap **Select All** and then tap **Delete**.
- Tap **Quick access** to directly navigate to the function selection page of last diagnostic operation. Choose the desired option to proceed.

5.4 Feedback

This function enables you to feedback the diagnostic issues to us for analysis and troubleshooting.

Tap **Feedback**, and tap **OK** to enter into the vehicle diagnostic record page.

A. Feedback

Tap the target vehicle to enter the feedback page.

B. History

Tap it to view the diagnostic feedback logs which are marked with different color indicating the process status of the diagnostic feedback.

C. Offline list

Tap it to enter the diagnostic feedback offline list page. Once the tablet gets a

LAUNCH

stable network signal, it will be uploaded to the remote server automatically.

6 Service (Reset) Function

It offers coding, reset, relearn and more service functions, to help vehicles get back to functional status after repair or replacement. Available tests vary by vehicle manufacturer, year, and model.

Due to continuing improvements, the available service functions are subject to change at any time. To enjoy more service functions, you are suggested to check for updates on a regular basis.

6.1 Maintenance Light Reset (Oil Reset)

This function enables you to reset the oil service for the engine oil life system, which calculates an optimal oil life change interval depending on the vehicle driving conditions and weather events.

It needs to be performed in the following cases:

1. If the service lamp is on, run car diagnostics first for troubleshooting. After that, reset the driving mileage or driving time, so as to turn off the service lamp and enable a new driving cycle.
2. If the service lamp is not on, but you have changed the engine oil or electric appliances that monitor oil life, you need to reset the service lamp.

6.2 Electronic Parking Brake Reset (BRAKE RESET)

This function enables you to reset the brake pad after replacing the brake pad.

It needs to be performed in the following cases:

1. The brake pad and brake pad wear sensor are replaced.
2. The brake pad indicator lamp is on.
3. The brake pad sensor circuit is short, which is recovered.
4. The servo motor is replaced.

6.3 Steering Angle Reset (SAS Reset)

This function enables you to reset the steering angle, after replacing the steering angle position sensor, replacing steering mechanical parts (such as steering gearbox, steering column, end tie rod, steering knuckle), performing four-wheel alignment, or recovering car body.

To reset the steering angle, first find the relative zero point position for the car to

drive in straight line. Taking this position as reference, the ECU can calculate the accurate angle for left and right steering.

6.4 ABS Bleeding

This function allows you to perform various bi-directional tests to check the operating conditions of Anti-lock Braking System (ABS).

It needs to be performed in the following cases:

1. When the ABS contains air.
2. When the ABS computer, ABS pump, brake master cylinder, brake cylinder, brake line, or brake fluid is replaced.

6.5 Crank Position Sensor Adaptive Learning (GEAR LEARN)

This function enables you to perform tooth learning for the car, to turn off the MIL.

It needs to be performed in the following cases:

1. After the engine ECU, crankshaft position sensor, or crankshaft flywheel is replaced.
2. The DTC 'tooth not learned' is present.

6.6 Anti-theft Matching (IMMO)

This function enables you to perform the anti-theft key matching function, so that the immobilizer control system on the car identifies and authorizes remote control keys to normally use the car.

It needs to be performed in the following cases:

When the ignition switch key, ignition switch, combined instrument panel, ECU, BCM, or remote control battery is replaced.

6.7 Injector Coding (INJECTOR)

This function enables you to write injector actual code or rewrite code in the ECU to the injector code of the corresponding cylinder, so as to more accurately control or correct cylinder injection quantity.

It needs to be performed in the following cases:

After the ECU or injector is replaced.

6.8 Battery Matching (BAT. RESET)

This function enables you to perform a resetting operation on the monitoring unit of vehicle battery, in which the original low battery fault information will be cleared and battery matching will be done.

It needs to be performed in the following cases:

1. The main battery is replaced.
2. The battery monitoring sensor is replaced.

6.9 DPF Regeneration (DPF REG.)

This function enables you to clear PM (Particulate Matter) from the DPF filter through continuous combustion oxidation mode (such as high temperature heating combustion, fuel additive or catalyst reduce PM ignition combustion) to stabilize the filter performance.

It needs to be performed in the following cases:

1. The exhaust back pressure sensor is replaced.
2. The PM trap is removed or replaced.
3. The fuel additive nozzle is removed or replaced.
4. The catalytic oxidizer is removed or replaced.
5. The DPF regeneration MIL is on and maintenance is performed.
6. The DPF regeneration control module is replaced.

6.10 Throttle Matching (ELEC. THROTTLE RLRN)

This function enables you to make initial settings to throttle actuators and returns the learned values stored on ECU to the default state. Doing so can accurately control the actions of regulating throttle (or idle engine) to adjust the amount of air intake.

6.11 Gearbox Matching (GEARBOX)

This function enables you to complete the gearbox self-learning to improve gear shifting quality.

It needs to be performed in the following cases:

When the gearbox is disassembled or repaired.

6.12 Headlight Matching (AFS RESET)

This function enables you to initialize the adaptive headlamp system.

6.13 Sunroof Initialization (SUNROOF)

This function enables you to set the sunroof lock off, closed when it rains, sliding / tilting sunroof memory function, temperature threshold outside the car etc.

6.14 Suspension Level Calibration (SUS RESET)

This function enables you to adjust the height of the body.

It needs to be performed in the following cases:

1. When replacing the body height sensor, or control module in the air suspension system.
2. When the vehicle height is incorrect.

6.15 EGR Adaption

This function is used to learn the EGR (Exhaust Gas Recirculation) valve after it is cleaned or replaced.

6.16 Seats Calibration

This function is applied to match the seats with memory function that are replaced and repaired.

6.17 Tyre Reset

This function is used to set the size parameters of the modified or replaced tire.

6.18 Coolant Bleed

Use this function to activate the electronic water pump before venting the cooling system.

6.19 AdBlue Reset (Diesel Engine Exhaust Gas Filter)

After the diesel exhaust treatment fluid (car urea) is replaced or filled up, urea reset operation is required.

6.20 NOx Sensor Reset

NOx sensor is a sensor used to detect the content of nitrogen oxides (NOx) in engine exhaust. If the NOx fault is re-initialized and the NOx catalytic converter is replaced, it is necessary to reset the catalytic converter learned value stored in the engine ECU.

6.21 AC System Relearn/Initialization

AC system relearn/initialization must be performed when the vehicle AC ECU or actuator is replaced or the ECU memory is lost.

6.22 High Voltage Battery Detection (HIGH VOLTAGE BATTERY)

This function is used for high voltage battery diagnosis and status information detection.

6.23 Windows Calibration

This function is used to perform door window matching to recover the ECU initial memory, and recover the automatic ascending and descending function of power window.

6.24 Language Change

This function is used to change system language of vehicle center console.

6.25 A/F Reset

This function is applied to set or learn air/fuel rate parameters.

6.26 Transport Mode

To lower vehicle power consumption, user may perform the following operations: limit vehicle speed, not wake up the network for door open and disable remote key etc. In this case, deactivating transport mode is needed to recover vehicle being normal.

6.27 Stop/Start Reset

This function is used to open or close the automatic Start/Stop function via setting the hidden function in ECU (The precondition is vehicle equipped with

hidden function and hardware support).

6.28 Intelligent Cruise Control System Reset

This function is used to matching the intelligent cruise control module after it is replaced or repaired.

6.29 Engine Power Balance Monitoring

This function is used to monitor crankshaft acceleration in the power stroke of each cylinder, to determine the relative power provided by each cylinder.

6.30 Gas Particulate Filter (GPF) Regeneration

This function is used to perform the GPF replacement or regeneration after the fuel consumption is increased and engine output power is reduced resulting from a long time service of the GPF.

6.31 Motor Angle Calibration

This function is used to perform the motor angle calibration when the rotor position detected by the motor angle position sensor is different from the actual rotor field position.

7 Software Update

This module enables you to update the diagnostic software & App and frequently used software.

7.1 Update Diagnostic Software & APP

Go to **Software Update** on the Home screen and tap the **Downloaded** tab.

The **Available** tab displays a list of software that can be updated. Under it, all software is categorized into three kinds:

- **Common software:** mainly includes some common apps that are associated with the diagnostic app. The software of this kind always stays at the top of the list, which can be deselected manually (excluding the system app, such as firmware and ECU aid).
 - **Frequently used vehicle software:** refers to the diagnostic software that is frequently used, including the vehicle diagnostic software and Reset software. It is generally displayed following the **Common software** list.
 - **Other vehicle software:** refers to the diagnostic software that is rarely used or never used. It is generally displayed following the **Frequently used software** list.
- 1). If the user does not download any diagnostic software during the sign-up process, all diagnostic software is selected by default. Tap **Update** to start downloading.
 - 2). If the user downloaded all/some vehicle software during the sign-up process and had it serviced for a long period of time, only the frequently used software is selected. Tap **Update** to start downloading. Other vehicle software that is rarely used will also be listed under the **Available** tab, but it is not selected at default.

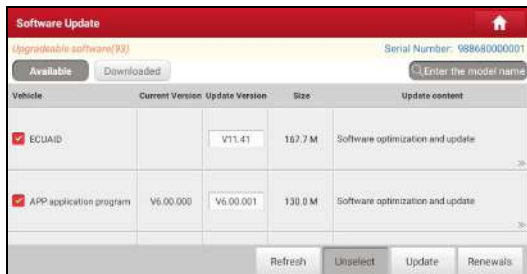

To download certain software that is not frequently used, check the box before the vehicle model. Tap **Update** to start downloading.

Once download is finished, the software packages will be installed automatically.

7.2 Update Frequently Used software

If the user only intends to update the frequently used software, go to Software Update and tap the **Downloaded** tab.

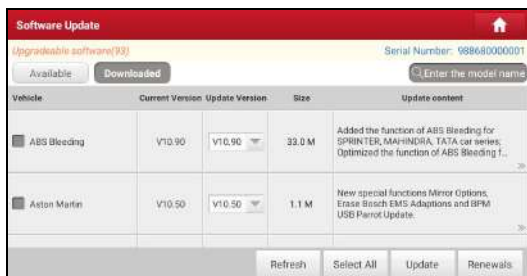

Tap **Update** to start downloading. Once download is finished, the software packages will be installed automatically.

7.3 Renew Subscription

If the software subscription is due or expires, the system will prompt you to renew your subscription.

Tap **Renewal** on the bottom of the screen to enter the payment screen.

There are three ways available for you to make payment: PayPal, Subscription Renewal Card (*need to buy it from the seller where you purchased the tool) and

LAUNCH

Credit Card.

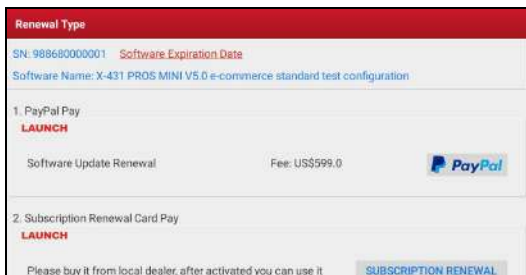

1. Using PayPal

1. Select **PayPal**, and then follow the on-screen instructions to finish the transaction.
2. After payment, go to update center to update the diagnostic software.

2. Using Subscription Renewal Card

1. Select **Subscription Renewal Card**.



2. Input the 24-digit pin code of Subscription Renewal Card and then tap Submit to finish the renewal.
3. Go to update center to update the diagnostic software.

3. Using Credit Card

1. Select **Credit Card**, and then follow the on-screen instructions to finish the transaction.
2. After payment, go to update center to update the diagnostic software.

8 User Info

This function allows users to manage personal information and VCI.

8.1 My Report

This option is used to view, delete or share the saved reports.

Tap **My Report**, there are total 2 options available.

In case the DTC result is saved on Read Trouble Code page, the files will be listed under **Diagnostic Report** tab.

If user records the running parameters while reading data stream, the tablet will save the file which appears under **Diagnostic Record** tab.

8.2 VCI

This option allows you to manage all your activated VCI devices.

If several VCI devices are activated on this tool, a list of VCIs will be displayed on the screen. Once you choose the VCI that belongs to other account, you have to log out, and then input the right account to continue.

8.3 VCI Management

This option is used for the tablet to deactivate pairing up with the VCI device via Bluetooth.

8.4 Activate VCI

This option lets you activate the VCI device in case you ignore the Activate VCI step in process of the product sign-up.

Input the Serial Number and Activation Code, and then tap **Activate** to activate the VCI.

8.5 Firmware Fix

This option is used to upgrade and fix diagnostic firmware. During fixing, please do not cut power or switch to other interfaces.

8.6 My Order

This option allows you to check the status of all your orders.

8.7 Subscription Renewal Card

This option is used to check the status of the subscription renewal card.

Input the 12-digit subscription renewal card number. Tap **Search** to get the search result.

8.8 Profile

Use this option to view and configure personal information.

8.9 Change password

This option allows you to modify your login password.

8.10 Settings

This option enables you to make some in-app settings and view software version information etc.

8.10.1 Units

This option is designed to configure the measurement unit. Metric System and English System are available.

8.10.2 Shop Information

This option lets you define your shop information. It mainly includes Workshop, Address, Telephone, Fax and License Plate.

Once you saved the shop information, it will be entered automatically in the *Add Information* box every time you save the diagnostic report.

8.10.3 Printer Set

This option is designed to establish a wireless connection between the tablet and the Wi-Fi printer (sold separately) while performing printing operations.

For more details on printer setting, refer to the User Manual of Wi-Fi printer.

8.10.4 Clear Cache

This option allows you to clear the App cache. Clearing the cache will restart the App.

8.10.5 About

This option allows you to check the software version information and disclaimer.

8.10.6 Login/Logout

To logout the current user ID, tap **Logout**.

To login the system again, tap **Login**.

8.11 Diagnostic Software Clear

This option allows you to hide/clear the diagnostic software that is not frequently used.

 Note: Removing software may completely delete the software from the tablet. If some software is not used and the tablet runs out of space, you can use this feature to remove it.

9 Other Modules

9.1 Testable Models

This function allows you to check the vehicle models that the tool covers.

9.2 Tablet Setting

This function provides a quick dial to the Android's system settings.

9.3 Files

This module is a very useful file & application manager, task killer and download manager.

9.4 System OTA Upgrade

This function allows you to perform system update.

An Over-the-Air (OTA) update is the wireless delivery of new operating system, software or data to tablets. Wireless carriers have traditionally used over-the-air updates to deploy firmware and configure tablets for use on their network.

9.5 Recording Master

This module is a free and convenient application that allows you to take tablet screen video capture of high quality, with or without sound.

9.6 Calculator

It is a simple-to-use and responsive app. All calculations are made on-the-fly as you input new data.

9.7 Browser

This browser is a free cross-platform web browser. It has gained popularity worldwide, featuring tools such as file downloads, password settings, and bookmarks. Users can load several web pages or use a search engine to find any topic on the internet.

9.8 Gmail

It is an easy-to-use email app that saves you time and keeps your messages safe. Get your emails instantly via push notifications, read and respond online & offline, and find any email quickly.

9.9 Camera

This function allows you to take pictures or record videos with the device camera.

9.10 Gallery

This function allows you to take new pictures and manage the picture library (including screenshots).

10 FAQ

1. How to save power?

- Please turn off the screen while the tool keeps idle.
- Set a shorter standby time.
- Decrease the brightness of the screen.
- If WLAN connection is not required, please turn it off.
- Disable GPS function if GPS service is not in use.

2. How to connect the non-OBD II vehicle diagnostic socket?

- 1) Select the appropriate adaptor from the non-16pin adaptor kit (sold separately) according to the vehicle's DLC port type (4).
- 2) Loosen the captive screws of the HDB15F to HD15F data cable (2) and disconnect the HD15M to OBD16 adaptor (3) from the data cable.
- 3) Connect the data cable (2) with the target adaptor on the above figure and tighten the screws. Other steps shall also apply.

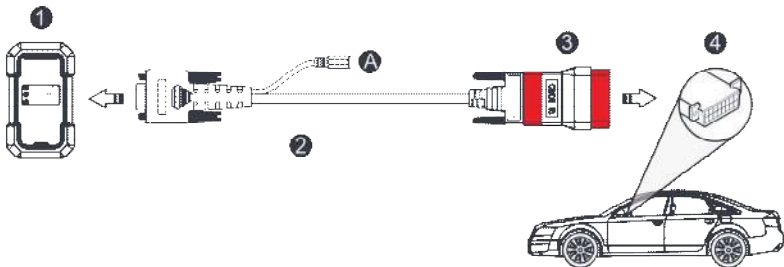

4. Communication error with vehicle ECU?

Please confirm:

1. Whether the VCI is correctly connected.
2. Whether ignition switch is ON.
3. If all checks are normal, send vehicle year, make, model and VIN number to us using Feedback feature.

5. Failed to enter into vehicle ECU system?

LAUNCH

Please confirm:

1. Whether the vehicle is equipped with this system.
2. Whether the VCI is correctly connected.
3. Whether ignition switch is ON.
4. If all checks are normal, send vehicle year, make, model and VIN number to us using Feedback feature.

6. How to download the Diagnostic App after resetting the tablet?

*Note: Before registration, please make sure the network is properly connected.

After the tablet has been successfully reset, follow the steps below to download the App:

1. Launch the browser and the default official Launch website opens (If a blank page pops up, just type in www.x431.com in the input bar).
2. Tap **Login**, input the username and password and tap **Log In**.
3. Make sure that the serial number is correct, tap **APP application program** and tap the Download icon to start downloading.
4. After the download is complete, follow the on-screen instructions to install it.
5. After installation, use the existing username and password to login and go to update center to download the diagnostic software.

7. What to do if the language of vehicle diagnostic software does not match the system language?

English is the default system language of the tool. After the system language is set to the preference language, please go to the update center to download the vehicle diagnostic software of the corresponding language.

If the downloaded diagnostic software is still displayed in English, it indicates that the software of the current language is under development.

8. How to retrieve the login password?

Please follow below steps to proceed in case you forgot the login password:

1. Tap the application icon on the home screen to launch it.
2. Tap **Login** on the upper right corner of the screen.
3. Tap **Retrieve password**.

LAUNCH

Warranty

This warranty is expressly limited to persons who purchase LAUNCH® products for purposes of resale or use in the ordinary course of the buyer's business.

LAUNCH® electronic product is warranted against defects in materials and workmanship for one year (12 months) from date of delivery to the user.

This warranty does not cover any part that has been abused, altered, used for a purpose other than for which it was intended, or used in a manner inconsistent with instructions regarding use. The exclusive remedy for any automotive meter found to be defective is repair or replacement, and LAUNCH shall not be liable for any consequential or incidental damages.

Final determination of defects shall be made by LAUNCH in accordance with stipulated procedures.

Order Information

Replaceable and optional parts can be ordered directly from your authorized tool supplier. Your order should include the following information:

- Quantity
- Part number
- Item description

Customer Service

If you have any questions on the operation of the unit, please contact the seller, or customer service center:

Tel: 86-755-25938674

E-mail: DOD@cnlaunch.com