

**MOTO-1-BMW**

## OPERATING INSTRUCTION

Dear Customers:

The tool you have chosen is part of the MOTO-1<sup>®</sup> range of products, it covers the whole technology our staff has acquired in its years long experience. It will be a useful working tool to satisfy both you and your customers. MOTO-1<sup>®</sup> is glad to include you among its Customers; In addition, thanks to wide our range of products. We are sure we will satisfy your current and future needs.

Our authorized dealers and "Customer service" will solve any technical problem for you completely.

## Points for Attention

This manual is an undivided part of the product. It describes technical features and functions of the product. Please read these instructions carefully before using this tool and store it for future needs.

1. When the engine is running, please insure the ventilation or connecting the building exhaust fan system with the vehicle exhaust system to exhale the waste gas. Because the Carbon Monoxide, which ejected by the engine, is a colorless and odourless gas. Once inhaled to excess, it can cause serious physical injury even death.
2. Before using the diagnostic scanner, please insure that you have parked the motorcycle solidly. Please don't operate the diagnostic scanner during the driving process.
3. When you operate the diagnostic scanner during the engine running, please keep enough distance from any running parts of the engine or the driving belt. Because the running parts of engine or the driving belt may engulf clothes, the connecting line of the diagnostic scanner or any part of the Conner's body to lead serious hurt.
4. Unless there is other operation direction, you must turn off the ignition when connecting or removing the line of electronic circuit components.
5. When the engine is running, please don't touch the ignition coil, the ignition coil terminals or the spark plug, which can produce very high voltage.
6. This diagnostic scanner has a safe design which can prevent the battery from being connected reversely, but we still recommend users strongly that you must verify the polarity of battery before connecting with the scanner.
7. Never put the diagnostic scanner on the battery. Because it is very likely to lead battery short-circuit, and cause personnel hurt, equipment damage and vehicle trouble.
8. Please don't touch the exhaust, engine or radiator system when it is running or just finished running. If you have to touch the hot parts, please wear the tested heat-resistant gloves to avoid burn.
9. Please don't expose the scanner in the flammable gas or steam.
10. This diagnostic scanner belongs to precise electronic product, please don't unweave or repair it by yourself.
11. If there is any adjustment during the actual producing, not separate informs even slightly.

# INDEX

|  |    |
|--|----|
| 1. Product Configuration.....                            | 2  |
| 1.1 External View of Mainframe .....                     | 2  |
| 1.2 Technical parameters .....                           | 3  |
| 2.Function Introduction.....                             | 4  |
| 2.1 Mainframe power supply modes.....                    | 4  |
| 2.2 Menu introduction of boot-strap .....                | 4  |
| 2.3 System Diagnosis Menu .....                          | 5  |
| 2.4 System Information Menu .....                        | 5  |
| 2.5 Software Updating Menu.....                          | 6  |
| 3. System Diagnoses .....                                | 6  |
| 3.1 Introduction of system diagnoses.....                | 6  |
| 3.2 Reading ECU information .....                        | 9  |
| 3.3 Reading DTC .....                                    | 11 |
| 3.4 Clear DTC.....                                       | 12 |
| 3.5 Read DataStream .....                                | 14 |
| 3.6 Action Testing.....                                  | 14 |
| Addendum I: Treatment Measures For Common Problems ..... | 17 |

# 1. Product Configuration

## 1.1 External View of Mainframe

### 1.1.1 Ichnography of the right side of Mainframe



Mainframe Length: 220mm  
Mainframe Width: 150mm  
Vision Screen Length: 104mm  
Vision Screen Width: 81mm

#### **Instruction of keyboard**

[ENTER] key: confirmation to the current option

[EXIT] key: Negation to the problem or return to the last menu

[↑] key: Upward movement

[↓] key: Downward movement

[→] key: Move forward

[←] key: Move backward

[RESET] key: Function key

### 1.1.2 The top of mainframe Operating introduction

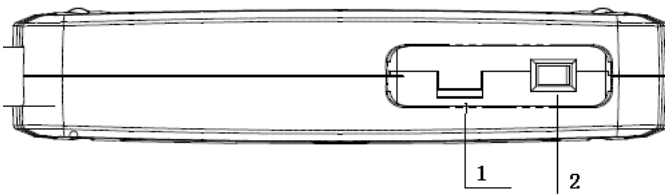

1. Brightness adjusting knob of the Mainframe screen

2. Power supply switch of the Mainframe

### 1.1.3 The bottom of mainframe Operating Introduction

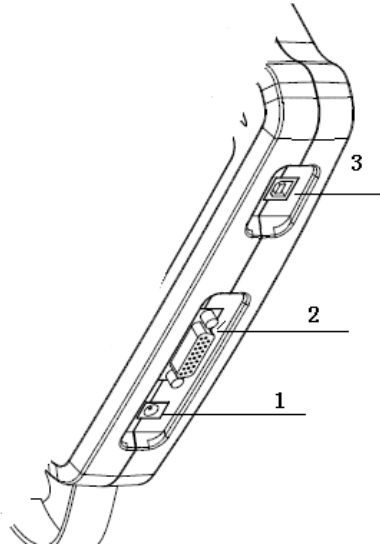

- 1.power supply insert
- 2.diagnose interface
- 3.USB interface

## 1.2 Technical parameters

Working Voltage: DC12V

Working current: <1A

Working temperature:0-40°C

Humidity: <80%

## 2.Function Introduction

### 2.1 Mainframe power supply modes

MOTO-1 BMW diagnostic Scanner can work by using several power supply modes.

1. Motorcycle diagnostic connector power supply.
2. A.C.transformer power supply
3. Provide electricity with USB interface, mainly used during the software updating.

### 2.2 Menu introduction of boot-strap

After electrifying the mainframe, turn on the power supply. The mainframe displays the application object of the scanner: BMW MOTORCYCLE SCANNER. After waiting for 1sec. it can enter the main menu automatically.

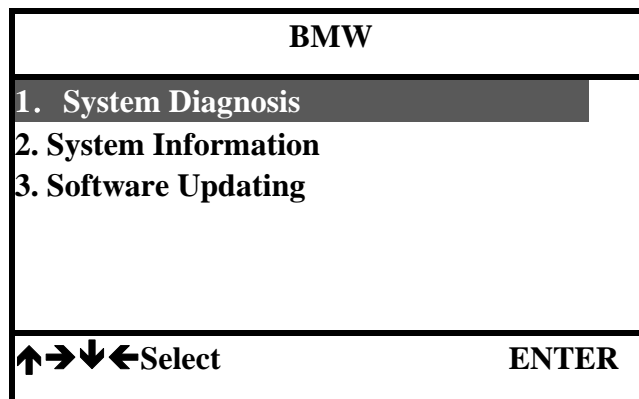

The main menu displays the function menu which is collocated in the mainframe of MOTO-1 BMW diagnostic Scanner. There are three correlative function menus. As shown in the picture above, the black item means the choosing item.

## 2.3 System Diagnosis Menu

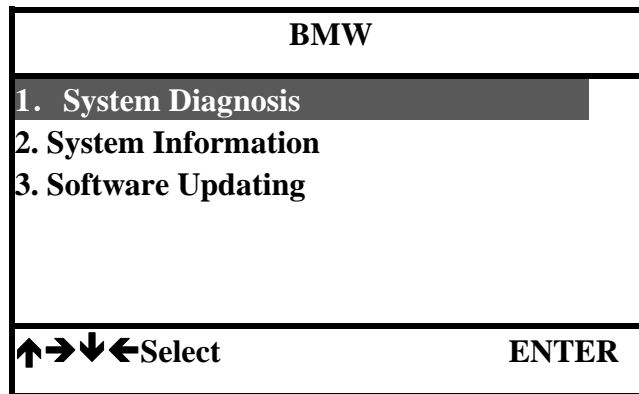

This menu is the main menu of this diagnostic scanner; all the diagnostic functions enter from this menu. Because of its importance, we will give a detailed description in the later section.

## 2.4 System Information Menu

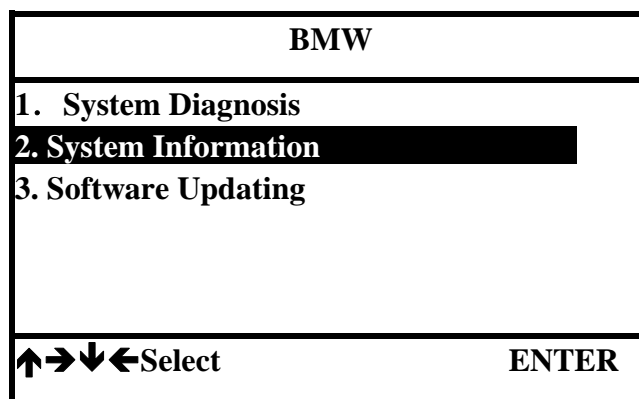

This menu displays some specific information of the diagnostic scanner. After pressing the [ENTER] key, it appears the following interface.

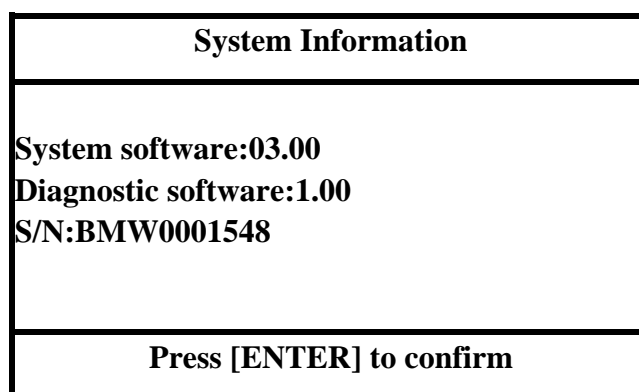



## 2.5 Software Updating Menu

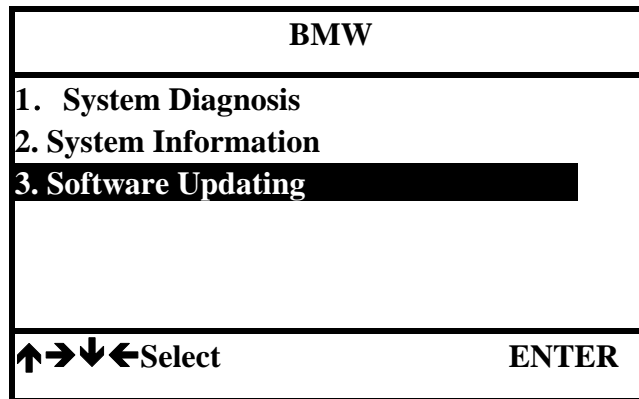

This function will be used when updating the software. According to this operation direction, you can finish the software update process.

## 3. System Diagnoses

### 3.1 Introduction of system diagnoses

Connect diagnostic connector to the motorcycle diagnostic connector and turn on the ignition switch. If there is not power supply in the diagnostic connector, you need to connect with the alligator clip to get electricity from the battery. Open the power supply switch of the diagnostic scanner, and enter the following interface.

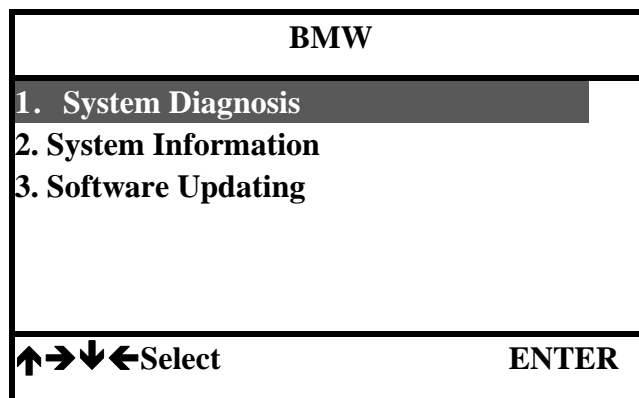

Press the [ENTER] key to enter the following interface.

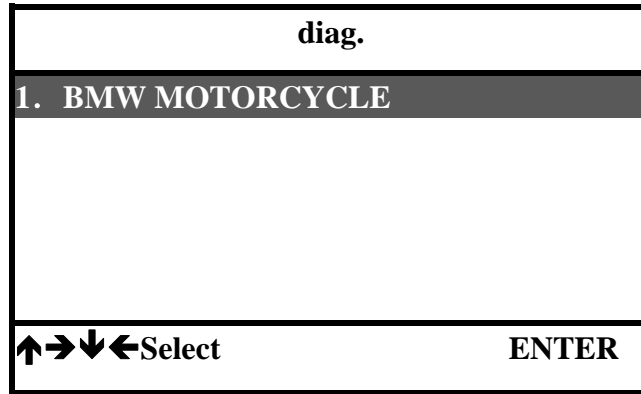

Press [ENTER], then [ ↓ ] key to enter the following interface.

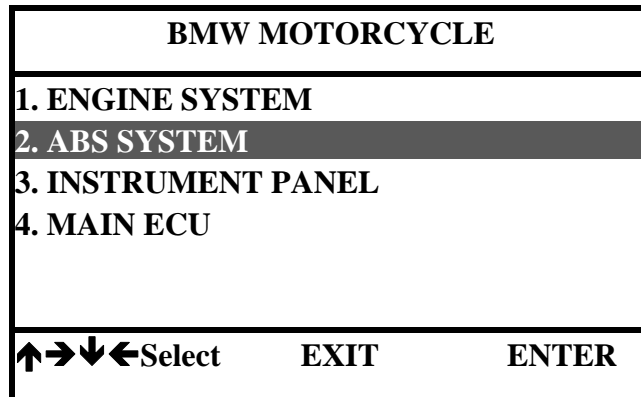

Because there are so many vehicle models and systems, here we make ABS system as an example to explain how to operate. After pressing [ENTER] key, it displays the following interface.

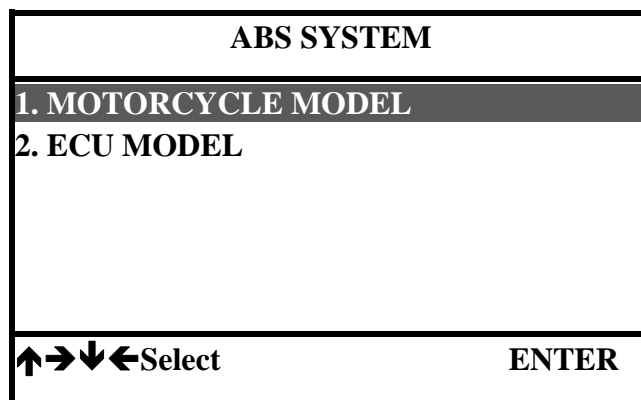

Press [ENTER] key, it displays the following interface.

| MOTORCYCLE MODEL |        |                 |
|------------------|--------|-----------------|
| 1. C             | SERISE |                 |
| 2. F             | SERISE |                 |
| 3. G             | SERISE |                 |
| 4. K             | SERISE |                 |
| 5. R             | SERISE |                 |
| ↑→↓←             | Select | EXIT      ENTER |

Continue to press [ ↓ ]key, and choose[4.K SERISE]. As show below.

| MOTORCYCLE MODEL |        |                 |
|------------------|--------|-----------------|
| 1. C             | SERISE |                 |
| 2. F             | SERISE |                 |
| 3. G             | SERISE |                 |
| 4. K             | SERISE |                 |
| 5. R             | SERISE |                 |
| ↑→↓←             | Select | EXIT      ENTER |

Press [ENTER], it displays the following interface.

| K SERISE                     |        |                 |
|------------------------------|--------|-----------------|
| 1. K 1100 LT ABS [94-99]     |        |                 |
| 2. K 1100 LT Highline        |        |                 |
| 3. K 1100 LT Special Edition |        |                 |
| 4. K 1100 LT RS ABS [94-97]  |        |                 |
| 5. K 1200 GT [03-05]         |        |                 |
| 6. K 1200 GT [06-..]         |        |                 |
| 7. K 1200 LT [99-01]         |        |                 |
| ↑→↓←                         | Select | EXIT      ENTER |

### 3.2 Reading ECU information

Choose [5. K 1200 GT [03-05]], and press [ENTER]. It displays the following interface.

|  |
|--|
| <b>BMW</b>   |
| <b>start up after the key and the antitheft closed</b> |
| <b>Press [ENTER] to confirm</b>                        |

Press [ENTER], it displays the following interface.

|   |
|---|
| <b>BMW</b>                                  |
| <b>Open the key and start up the engine</b> |
| <b>Press [ENTER] to confirm</b>             |

Press [ENTER], it displays the following interface.

|                                      |
|--------------------------------------|
| <b>BMW</b>                           |
| <b>Communication, please wait...</b> |

If it fails to communicate with ABS ECU, it will display the following interface.

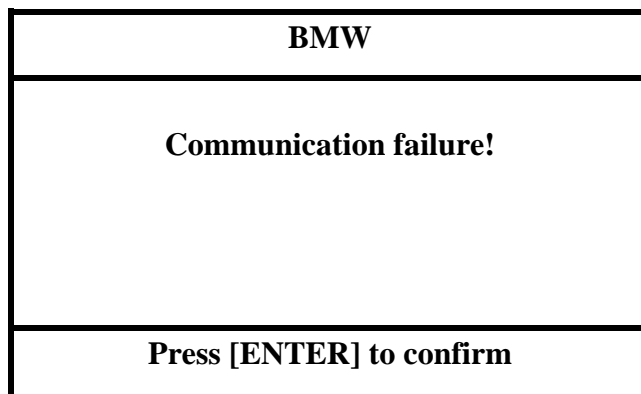

If it succeeds to communicate with ABS ECU, it displays the following interface.

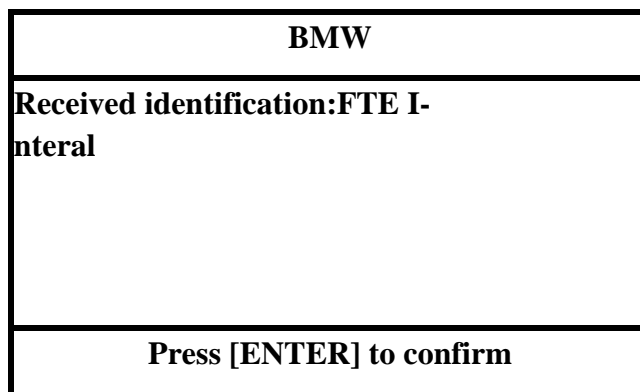

Press [ENTER], it displays the following interface.

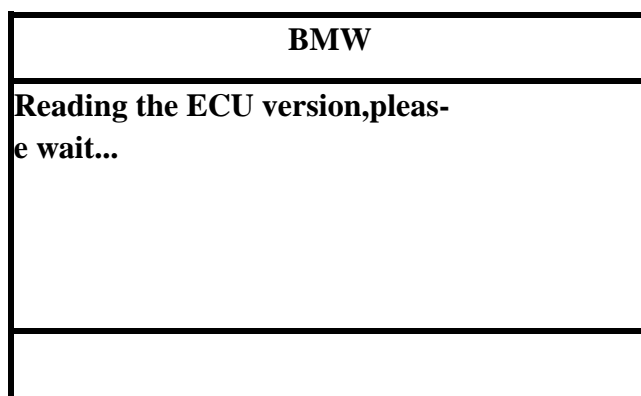

It prompts “Reading the ECU version”. After that, it displays the following interface.

|                                      |                  |              |
|--------------------------------------|------------------|--------------|
| <b>BMW</b>                           |                  |              |
| <b>BMW code NO.:2333510</b>          |                  |              |
| <b>HW version:19</b>                 |                  |              |
| <b>Index coding:10</b>               |                  |              |
| <b>Diagnostic index:BC</b>           |                  |              |
| <b>System name:6B6C</b>              |                  |              |
| <b>Date of manufacture:20/6/2002</b> |                  |              |
| <b>Manufacture:40</b>                |                  |              |
| <b>←PageUp</b>                       | <b>→PageDown</b> | <b>ENTER</b> |

Press [→]to continue to select screen and look over other ECU version info. Press [ENTER] to display the following interface.

|                           |             |              |
|---------------------------|-------------|--------------|
| <b>SELECT FUNCTION</b>    |             |              |
| <b>1. ECU information</b> |             |              |
| <b>2. Read DTC</b>        |             |              |
| <b>3. Clear DTC</b>       |             |              |
| <b>4. Read datastream</b> |             |              |
| <b>5. Action test</b>     |             |              |
| <b>↑ → ↓ ←Select</b>      | <b>EXIT</b> | <b>ENTER</b> |

The function of [1.ECU information] has been talked in front. We don't explain it any more.

### 3.3 Reading DTC

Select [2.Read DTC], and press [ENTER], it appears the following interface.

|  |  |  |
|--|--|--|
| <b>BMW</b>                             |  |  |
| <b>Reading the DTCs,please wait...</b> |  |  |
|  |  |  |
|  |  |  |

After reading the DTCs, it displays the following interface.

|  |             |
|--|-------------|
| <b>BMW</b>                                     |             |
| <b>C031E The wheel coil pressure is high</b>   |             |
| <b>C041E The rear wheel coil pressure high</b> |             |
| <b>DTC number :2</b>                           | <b>EXIT</b> |

### 3.4 Clear DTC

Select [3.Clear DTC]. It appears the following interface.

|                           |             |              |
|---------------------------|-------------|--------------|
| <b>SELECT FUNCTION</b>    |             |              |
| <b>1. ECU information</b> |             |              |
| <b>2. Read DTC</b>        |             |              |
| <b>3. Clear DTC</b>       |             |              |
| <b>4. Read datastream</b> |             |              |
| <b>5. Action test</b>     |             |              |
| ↑ → ↓ ←Select             | <b>EXIT</b> | <b>ENTER</b> |

Press [ENTER]. It displays the following interface.

|   |              |
|---|--------------|
| <b>SELECT FUNCTION</b>                    |              |
| <b>Are you sure to clear all the DTC?</b> |              |
| <b>EXIT</b>                               | <b>ENTER</b> |

Continue to press [ENTER]. It displays the following interface.

|                                 |
|---------------------------------|
| <b>BMW</b>                      |
| <b>Clearing, please wait...</b> |
|                                 |

Then, it enters the following interface.

|   |
|---|
| <b>BMW</b>                                    |
| <b>Open the key after close the –<br/>key</b> |
| <b>Press [ENTER] to confirm</b>               |

Press [ENTER]. It displays the following interface.

|                                  |
|----------------------------------|
| <b>BMW</b>                       |
| <b>Clearing has carried out!</b> |
| <b>Press [ENTER] to confirm</b>  |



### 3.5 Read DataStream

Select [4.Read datastream]. It appears the following interface.

| SELECT FUNCTION    |      |       |
|--------------------|------|-------|
| 1. ECU information |      |       |
| 2. Read DTC        |      |       |
| 3. Clear DTC       |      |       |
| 4. Read datastream |      |       |
| 5. Action test     |      |       |
| ↑ → ↓ ←Select      | EXIT | ENTER |

This function is used to display the current data condition of ECU system. Using this data,you can estimate the vehicle working condition. Press [ENTER].After the prompting information, it appears the following interface.

| Data stream  |           |              |
|--------------|-----------|--------------|
| Rear light   |           | Allow        |
| Break light  |           | Allow        |
| Front Break  |           | no Operation |
| Rear Break   |           | Operation    |
| Front engine |           | Close        |
| Rear engine  |           | Close        |
| Voltage      |           | 11.7v        |
| ←PageUp      | →PageDown | EXIT         |

Press [→] and continue to look over other data stream.

### 3.6 Action Testing

Select [5.Action test]. It appears the following interface.

| <b>SELECT FUNCTION</b>             |  |  |
|------------------------------------|--|--|
| <b>1. ECU information</b>          |  |  |
| <b>2. Read DTC</b>                 |  |  |
| <b>3. Clear DTC</b>                |  |  |
| <b>4. Read datastream</b>          |  |  |
| <b>5. Action test</b>              |  |  |
| ↑ → ↓ ←Select      EXIT      ENTER |  |  |

Press [ENTER]. It displays the following interface.

| <b>Action test</b>                 |  |  |
|------------------------------------|--|--|
| <b>1. General break light</b>      |  |  |
| <b>2. Weak break light</b>         |  |  |
| ↑ → ↓ ←Select      EXIT      ENTER |  |  |

Before testing the component, please check if there is any trouble in the current ECU. If it has some trouble, you can't test the component. Meanwhile, the scanner prompts information as below.

| <b>BMW</b>                                  |  |  |
|---|--|--|
| <b>Can not be the test,ECU record error</b> |  |  |
| <b>Press [ENTER] to confirm</b>             |  |  |

If there isn't any trouble, the component test can finish by itself. It displays the following information.

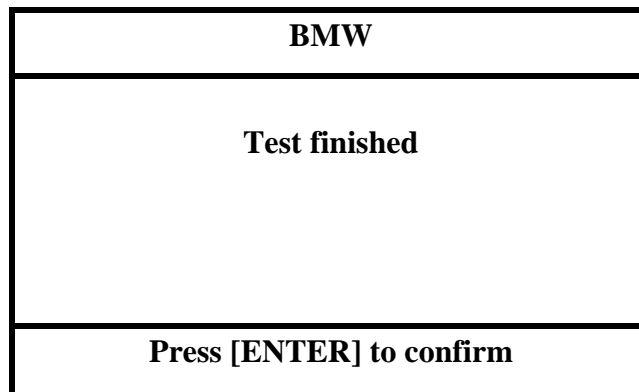

Through the component test, we can judge the working condition of ECU and executed components.

Addendum I: Treatment Measures For Common Problems

1. When testing the motorcycle ECU with the diagnostic scanner, it displays “Communication failure!” what is the problem? How to deal with it?

This problem is caused by the reasons as below:

1.1 The ECU model of diagnostic program you choose is different from the ECU model of motorcycle. Some motorcycles are modified. At this time, you can check the detailed model of the ECU, and choose the actual model from the “ECU MODEL” menu to test.

1.2 The ignition switch hasn't turned on to the “ON” position.

1.3 The cable between the diagnostic scanner and the diagnostic connector of motorcycle isn't connected reliable.

2. After electrifying the diagnostic instrument, press the switch of the mainframe, it displays white screen or black screen. What is the problem? How to deal with it?

2.1 Maybe you adjusted the adjustable knob of the mainframe by accident to lead the white screen or black screen of the mainframe. After starting up normally, adjust the offside adjustable knob on the top of the mainframe screen to make the mainframe display normally.

2.2 Check the power supply voltage of the diagnostic scanner is normal or not.